

Assembly Tool & Accessory CATALOG



Table of Contents

HAND TORQUE SCREWDRIVERS

- 1.1 Hand Torque Screwdriver Introduction
- 1.2 Ergo Micro Torque (Externally Adjustable Screwdrivers)
- 1.3-1.4 TLS (Internally Adjustable Screwdrivers)
- 1.5 CRS (Clean Room & Surgical Screwdrivers)
- 1.6 PSE (Internally Adjustable Screwdrivers)
- 1.7 TT (Dial Screwdrivers)
- 1.8 TorqueMate Electronic Screwdriver
- 1.9 Screwdriver Kits
- 1.10 Screwdriver Accessories

ASSEMBLY POWER TOOLS

- 2.1 Assembly Power Tools Introduction
- 2.2-2.3 Torque Charts
- 2.4 E-DRIIV BF-Series (Brushless Electric Screwdrivers)
- 2.5 E-DRIIV E-Series (Direct Plug-in Electric Screwdrivers)
- 2.6 E-DRIIV EF-Series & K-Series (Electric Screwdrivers)
- 2.7 SS-Series (Soft-Stop Electric Screwdrivers)
- 2.8 ESD Series (ESD Electric Screwdrivers)
- 2.9 A-Series (High Speed Electric Screwdrivers)
- 2.10 CL-Series (Electric Screwdrivers)
- 2.11 VZ-Series (Direct Plug-in Electric Screwdrivers)
- 2.12 VB-Series (Brushless Direct Plug-in Electric Screwdrivers)
- 2.13 E-DRIIV KA & BFA-Series (Robotic Screwdrivers)
- 2.14 BL-Series (Brushless Electric Screwdrivers)
- 2.15 Tool Balancers
- 2.16 Surefeed (Screw Presenters)
- 2.17-2.18 Transformers (Power Supplies for Electric Screwdrivers)
- 2.19-2.20 Accessories (for Electric Screwdrivers)
- 2.21 Vacuum Accessories (for Electric Screwdrivers)
- 2.22 Scout (Screw Counter)
- 2.23-2.24 PED & FED (Torque Control Driver Systems)
- 2.25 EZ-Glider (Linear Torque Arms)
- 2.26 EZ-Glider (Articulated Torque Arms)
- 2.27-2.28 EZ-Glider (Telescoping Torque Arm)
- 2.29 EZ-Slider (Torque Arms)

TORQUE WRENCHES

- 3.1 Torque Wrench Introduction
- 3.2 Torque Wrench Chart
- 3.3 TSC & TSP (Cam-Over Wrench)
- 3.4 TSN (Cam-Over Wrench)
- 3.5 STB (Cam-Over Breaking Wrench)
- 3.6 MTBN (Break-Over Wrench)
- 3.7 MMTB (Miniature Break-Over Wrench)
- 3.8 TBIH (Break-Over Wrench)
- 3.9 TB (Break-Over Wrench)
- 3.10 TBIH Heads, TB Heads and TB Bits
- 3.11 Titan (Click Wrench)
- 3.12 DM (Lightweight Click Wrench)
- 3.13 Insulated Torque Wrench
- 3.14 STW (Springless Torque Wrench)
- 3.15 TorqueMate Electronic Torque & Angle Wrench
- 3.16 RETW (Electronic Wrench)
- 3.17 EDTW (Electronic Dial Wrench)
- 3.18-3.19 Push Rod Wrench (Signal Output & TALS)
- 3.20-3.21 Dial Wrench
- 3.22 WSTT (Weld Stud Tool Tester)
- 3.23 Interchangeable Heads
- 3.24 SMA Heads and Ratchet Adapters

BITS, SOCKETS & ADAPTERS

- 4.1 Special Bits
- 4.2-4.3 Power Bits
- 4.4-4.5 Insert Bits
- 4.6 HIOS Bits
- 4.7 Miniature Bits
- 4.8 Bit Holders
- 4.9 Adapters & Sockets

REFERENCE

- 5.1 What is Torque?
- 5.2 Calculations

01 Hand Torque Screwdrivers

Section



TT
Dial Measuring
Torque Screwdriver
See Page 01.7

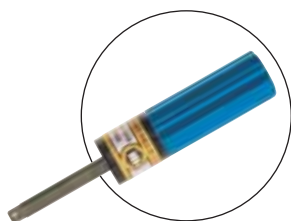

TLS
Torque Limiting Screwdriver
Internally Adjustable
See Pages
01.3 - 01.4



**CLEAN ROOM
DRIVERS**
Surgical Drivers
See Page 01.5



ERGO MICRO TORQUE
Torque Limiting Screwdriver
Externally Adjustable
See Page 01.2



PSE
Torque Limiting Screwdrivers
Internally Adjustable
See Page
01.6

The cam-over philosophy of each Mountz torque screwdriver prevents operators from influencing the torque output when tightening fasteners. Whether using a preset or adjustable tool, the patented design of each cam mechanism introduces a “slip” sensation when the set torque is reached. This slip is actually a precision ball or several balls aligning themselves in the next cam detent. Five models cover ranges from 0.7 ozf.in - 120 lbf.in.

Mountz offers the most complete array of torque screwdrivers available on the market today. **Internally Adjustable (preset)** models can be set over a wide range and sealed for tamper proof operation. Designed for production or field service environments these tools are simple to calibrate and offer years of reliable service. Mountz preset screwdrivers are available in a variety of colors to allow “color-coding” of torque values. Color coding allows torque values to be designated in a clear and simple manner to prevent error.

Mountz preset drivers are made for special applications as well. The advent of clean rooms in the medical and electronic industry prompted Mountz to introduce the first and only class 100 clean room approved torque screwdriver. **CRS** models have polished, sealed handles to prevent contamination. The **IFR Series** screwdrivers have a special cam to prevent “backlash”, which causes shock to assemblies such as disc drives, ceramics and other critical components or materials.

Externally Adjustable models offer versatile setting options for applications that require more than one torque value. Each tool incorporates a pull down ring to engage the adjustment mechanism. Simply turning the collar right or left increases or decreases torque respectively. Twenty-three adjustable models cover ranges from 0.5 ozf.in - 80 lbf.in.

The Mountz line of screwdriver Accessories allow the tools to be utilized in the most effective and productive manner. Screwdriver bits are available in a variety of lengths and configurations, including those made special for the most difficult access or application. Plastic grips aid in making the driver comfortable to the operator. In addition, each tool is available in a Tool Kit format for flexible and user friendly storage of common parts and accessories.

Most important is the quality of each product. Mountz screwdrivers are known to be reliable and accurate. The majority of equipment sold by Mountz meets or exceeds the principal requirements of International Standard ISO 6789:2003.

These standards state:

- The effective working range of a tool is from 20% to 100% of its maximum torque value.
- The accuracy requirements for Torque Screwdrivers is $\pm 6\%$ of reading.
- The maximum torque value for each square drive size.
- An overload ability of 125% of maximum torque capacity.
- A calibration life of 5000 cycles.
- Test and measuring procedures, at $20^\circ \pm 5^\circ$ C.
- The accuracy of calibration devices to be $\pm 1\%$ of reading or better.
- Scale and marking requirements.

Official ISO specification can be obtained by contacting: 212-642-4900



Ergo Micro Torque

Torque Limiting Screwdrivers
Externally Adjustable

Hand Torque
Screwdrivers

AMERICAN MODELS

Model	1/4" Male Square Drives	1/4" Female Hex Drives	Torque Ranges	Graduation
	Item #	Item #		
EMT60	020447	020441	10 - 60 ozf.in	1 ozf.in
EMT160	020448	020442	20 - 160 ozf.in	1 ozf.in
EMT4	020444	020439	0.5 - 4 lbf.in	0.1 lbf.in
EMT12	020446	020440	2 - 12 lbf.in	0.1 lbf.in
EMT50*	020454	020452	10 - 50 lbf.in	1 lbf.in
EMT80*	020458	020456	30 - 80 lbf.in	1 lbf.in

* Supplied with Sliding T-Bar

Model	Adjustable Ring Color	Overall Length		Overall Width		Weight	
		in.	mm.	in.	mm.	oz.	gm.
EMT60	Gold	6.3	159	1.0	25	4.3	124
EMT160	Blue	7.2	183	1.4	35	8.1	230
EMT4	Red	6.3	159	1.0	25	4.3	124
EMT12	Silver Grey	7.2	183	1.4	35	8.1	230
EMT50*	Red	7.7	196	1.5	37.5	11.8	335
EMT80*	Green	7.7	196	1.5	37.5	11.8	335

S.I. MODELS

Model	1/4" Male Square Drives	1/4" Female Hex Drives	Torque Ranges	Graduation
	Item #	Item #		
EMT40	020443	020437	5 - 40 cN.m	1 cN.m
EMT120	020445	020438	20 - 120 cN.m	1 cN.m
EMT6*	020453	020449	1 - 6 N.m	0.1 N.m
EMT9*	020457	020455	4 - 9 N.m	0.1 N.m

* Supplied with Sliding T-Bar

Model	Adjustable Ring Color	Overall Length		Overall Width		Weight	
		in.	mm.	in.	mm.	oz.	gm.
EMT40	Blue	6.3	159	1.0	25	4.3	124
EMT120	Blue	7.2	183	1.4	35	8.1	230
EMT6*	Red	7.7	196	1.5	37.5	11.8	335
EMT9*	Green	7.7	196	1.5	37.5	11.8	335

4mm FEMALE HEX DRIVE MODELS

Model	Item #	Torque Ranges	Graduation
EMT60	020490	10 - 60 ozf.in	1 ozf.in
EMT4	020489	0.5 - 4 lbf.in	0.1 lbf.in
EMT40	020488	5 - 40 cN.m	1 cN.m

Model	Adjustable Ring Color	Overall Length		Overall Width		Weight	
		in.	mm.	in.	mm.	oz.	gm.
EMT60	Gold	5.9	149	1.0	25	4.1	116
EMT4	Red	5.9	149	1.0	25	4.1	116
EMT40	Blue	5.9	149	1.0	25	4.1	116

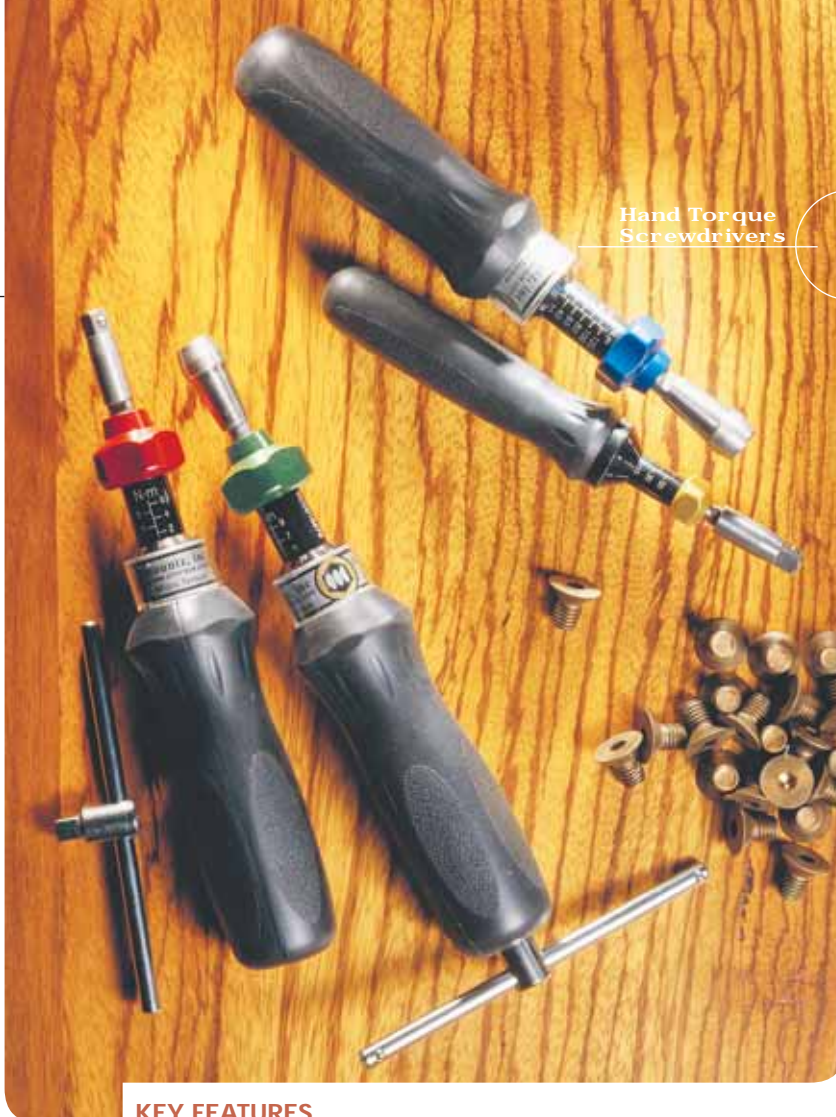

KEY FEATURES

The preferred and certified ranges of these tools is in accordance with the requirements of ISO 6789:2003 ($\pm 6\%$ of setting).

The "positive" locking system prevents incidental torque adjustment.

The bi-directional cam "slips-free" once the set torque has been reached making over-tightening impossible.

Adjustment ring disengages to prevent incidental torque adjustment.

Ergonomic rubber hand grip.

Precision radial ball clutch and cam allows for automatic resetting.

Micrometer adjustment allows for accurate tool setting.

Color coded adjustment ring allows for differentiation of models.

ESD compliant (IEC 61340-5-1:1998).



BITS

A wide variety of bits available.
See Pages 4.1 - 4.7



T-BAR

Removable 1/4" Sliding T-Bar
supplied with larger models.

Hand Torque
Screwdrivers



RTU

See Page
01.10

1/4" Male
Square
Adapter

See Page
01.10

Ergonomic
Grip

See Page
01.10

TLS

Preset Torque Limiting Screwdrivers (Internally Adjustable)

KEY FEATURES

Designed and manufactured to meet or exceed the accuracy and repeatability requirements of ISO 6789:2003 ($\pm 6\%$ of setting).

Various models that range from 0.7 ozf.in to 120 lbf.in.

Precision radial ball clutch "slips-free" when the preset torque is reached preventing overtorquing.

Thrust bearings insure that the torque setting is independent of any end load applied by the operator.

Bi-directional operation.

Four different colored lightweight aluminum handles allow color coding of specific torque values in production areas (TLS1360 - Black only).

ESD compliant (IEC 61340-5-1:1998).

FEATURES TLS-IFR

The design action of the standard TLS cammed screwdriver is such that when the tool reaches its preset torque value the mechanism disengages from the drive thus limiting the torque applied. Further rotation of the screwdriver handle resets the mechanism ready for the next torquing operation. The IFR models eliminates any small reaction during resetting.

All IFR models are "impact-free" when the cam resets.

Screwdriver is torque limiting in the CW direction only.

CCW operation available upon request.

FEATURES TLS-OWC

One-way clutch system is designed for the screwdriver to apply torque in one direction and lockup in the opposite direction for easy screw removal.

Ideal for maintenance and refurbishing applications.

Screwdriver is torque limiting in the CW direction only.

CCW operation available upon request.

1/4" male square drive models available upon request.



EASY TORQUE ADJUSTMENT

Tamper-proof internal adjustment. No external adjustment scale - must be preset using a torque analyzer.

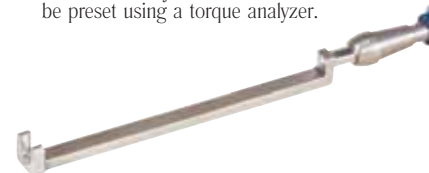

SMA Connector
See Page 03.24

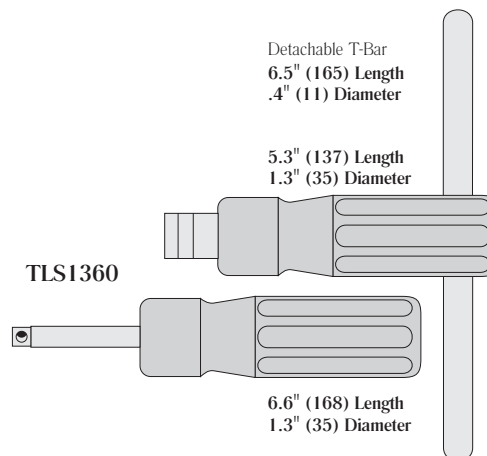
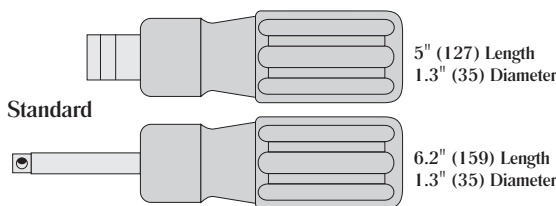
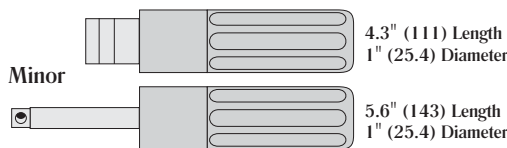
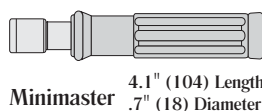
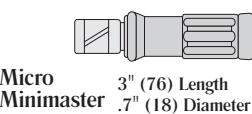
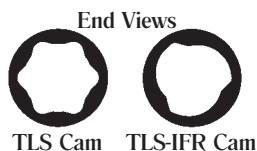

Model	1/4" Male Square Drives		1/4" Female Hex Drives			Color	Torque Ranges			Weight			
	TLS Item #	TLS-IFR Item #	TLS Item #	TLS-IFR Item #	TLS-OWC Item #		American	S.I.	Metric	TLS & IFR		TLS OWC	
										oz.	gm.	oz.	gm.
Micro Minimaster	-	-	020083	-	-	Red	3 - 32 ozf.in	2 - 22 cN.m	0.2 - 2.2 kgf.cm	1.8	50	-	-
Minimaster	-	-	020074	-	020289	Gold	0.7 - 32 ozf.in	0.5 - 22 cN.m	0.05 - 2.2 kgf.cm	2.5	72	3	86
Minor	020062	020465	020066	020464	020298	Blue	3 ozf.in - 12 lbf.in	2 - 135 cN.m	0.2 - 13.7 kgf.cm	7.4	210	7.9	224
	020063	020467	020067	020466	020301	Gold							
	020064	020469	020068	020468	020299	Green							
	020065	020471	020069	020470	020300	Red							
Standard	020075	020473	020079	020472	020302	Blue	8 ozf.in - 36 lbf.in	6 - 406 cN.m	0.6 - 41 kgf.cm	9.9	280	10.4	294
	020076	020475	020080	020476	020304	Gold							
	020077	020477	020081	020478	020293	Green							
	020078	020479	020082	020480	020303	Red							
TLS1360	020060	020481	020061	020482	020290	Black	10 - 120 lbf.in	1 - 13.6 N.m	10.5 - 138 kgf.cm	11.5	325	12	339



NOTE!

Clean Room models available, see page 01.5

CRS

Specialty Tools Clean Room Screwdrivers

Hand Torque
Screwdrivers



KEY FEATURES

- Designed and manufactured to meet or exceed the accuracy and repeatability requirements of ISO 6789:2003 ($\pm 6\%$ of setting).
- Exceeds Class 100 clean room standards.
- Special seals prevent contamination.
- External components are high grade stainless steel to inhibit any form of corrosion.
- Special microfiltered internal lubricant.
- Aluminum handle sealed with PTFE impregnated anodized finish.
- ESD compliant (IEC 61340-5-1:1998).
- Tamper-proof internal adjustment. No external adjustment scale - must be preset using a torque analyzer.

FEATURES IFR

- The design action of the standard CRS cammed screwdriver is such that when the tool reaches its preset torque value the mechanism disengages from the drive thus limiting the torque applied. Further rotation of the screwdriver handle resets the mechanism ready for the next torquing operation. The IFR models eliminate any small reaction during resetting.
- All IFR models are "impact-free" when the cam resets.
- Screwdriver is torque limiting in the CW direction only.
- CCW operation available upon request.

Model	Item #	Torque Ranges			Drive F/Hex	Weight	
		American	S.I.	Metric		oz.	gm.
CRS100-0022FH	020320	3 - 32 ozf.in	2 - 22 cN.m	0.2 - 13.7 kgf.cm	1/4"	2.5	72
CRS100-0135FH	020321	1 - 12 lbf.in	11 - 135 cN.m	1.1 - 13.7 kgf.cm	1/4"	7.4	210
CRS100-0406FH	020322	1.4 - 36 lbf.in	16 - 406 cN.m	1.6 - 41 kgf.cm	1/4"	9.9	280
CRS100-1360FH	020498	10 - 120 lbf.in	1 - 13.6 N.m	10.5 - 138 kgf.cm	1/4"	11.5	325
IFR CRS 100-00135FH	020483	1 - 12 lbf.in	11 - 135 cN.m	1.1 - 13.7 kgf.cm	1/4"	7.4	210
IFR CRS 100-00406FH	020484	1.4 - 36 lbf.in	16 - 406 cN.m	1.6 - 41 kgf.cm	1/4"	9.9	280

CLEAN ROOM STANDARDS

According to the United States specification FED-STD-209D, classes of cleanliness are defined by the number of particles per cubic foot.

Particle sizes shown in the following table.

MEASURED PARTICLE SIZE (Microns)

Class	0.1	0.2	0.3	0.5	5.0
1	35	7.5	3	1	-
10	350	75	30	10	-
100	-	750	300	100	-
1,000	-	-	-	1,000	7
10,000	-	-	-	10,000	70
100,000	-	-	-	100,000	700

For Torque Analyzers, ask for our "Torque Analyzer & Torque Measurement" catalog.



SURGICAL TORQUE TOOLS

Responding to an increasing demand for torque tools to be used in medical applications, Mountz, Inc. offers special surgical screwdrivers and wrenches.

The tools are manufactured from high quality materials providing the greatest resistance to the effects of temperature, wear, and corrosion. Where necessary, the tools have been modified to allow full ventilation/drainage of mechanism during sterilization/autoclaving.

All medical tools are non-standard and are not kept in stock. Contact our customer service to discuss your application requirements.

PSE

Preset Torque Limiting Screwdrivers Internally Adjustable

KEY FEATURES

Designed and manufactured to meet or exceed the accuracy and repeatability requirements of ISO 6789:2003 ($\pm 6\%$ of setting).

Precision radial ball clutch "slips-free" when the preset torque is reached preventing over-torquing.

Tamper-proof internal adjustment. No external adjustment scale - must be preset using a torque analyzer.

All models provide bi-directional operation.

Each model is only available in package quantity of 10 units.

ESD compliant IEC 61340-5-1:1998.



◀ Ergonomic rubber hand grip.

◀ Calibration label supplied in 4 colors, which can be used to mark pre-set details, date, etc.



1/4" MALE SQUARE DRIVE ADAPTER

Adapter can be used with any 1/4" Female Hex screwdriver to convert it into a 1/4" Male Square Drive screwdriver
See Page 01.10



T-BAR

Removable 1/4" Sliding T-Bar supplied with PSE1350.



Hand Torque Screwdrivers

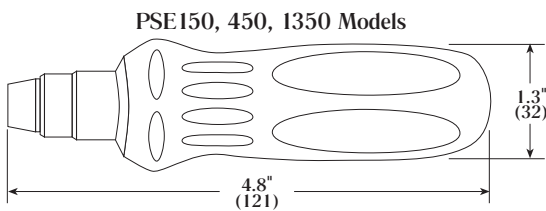
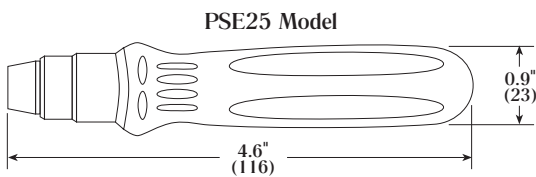

Model	Item #	Torque Ranges		
		American	S.I.	Metric
PSE25	020180	0.7 - 35 ozf.in	0.5 - 25 cN.m	0.05 - 2.5 kgf.cm
PSE150	020181	3 ozf.in - 13 lbf.in	2 - 150 cN.m	0.2 - 15.3 kgf.cm
PSE450	020172	8 ozf.in - 40 lbf.in	6 - 450 cN.m	0.6 - 45.8 kgf.cm
PSE1350*	020182	10 - 120 lbf.in	100 - 1350 cN.m	10.5 - 138 kgf.cm

* Supplied with sliding T-Bar

Model	Drive	Color	Weight	
			oz.	gm.
PSE25	1/4" Female/Hex	Gold	3.2	91
PSE150	1/4" Female/Hex	Red	6.5	185
PSE450	1/4" Female/Hex	Green	7.1	202
PSE1350	1/4" Female/Hex	Blue	8	229

PACKAGING DETAILS (Minimum Order)

Screwdrivers (same model) per box - 10 pcs
Individual Tool Calibration Certificates - 10 pcs
Torque Adjusting Key
1/4" Sliding T-Bars (PSE1350 only) - 10 pcs
Pre-set Labels - 40 pcs. (10 each of 4 colors)

Hand Torque
Screwdrivers

TT

Dial Measuring Torque Screwdrivers



**EASY DIAL
ADJUSTMENT**



American & S.I. scales

KEY FEATURES

The preferred and certified ranges of these tools is in accordance with ISO 6789:2003 ($\pm 6\%$ of indicated reading).

Covering a calibrated range of 14 ozf.in to 40 lbf.in.

Memory system holds maximum torque reached. TT dial measuring screwdrivers can be used to monitor torque as it increases or decreases or to display peak torque applied.

Flat tension spring is used to give the best linear characteristics in both directions.

Especially designed for torque evaluation and verification.

Quality constructed with stainless steel shafts, attractive colored aluminum handles and sturdy dials for maximum tool life.

Corrosion resistant.

Ideal tool for QC, R & D, and assembly operations.

ESD compliant (IEC 61340-5-1:1998).

Model	Item #	Calibrated Ranges		Handle Color
		American	S.I.	
TT50F/H	020151	14 - 70 ozf.in	10 - 50 cN.m	Gold
TT100F/H	020153	28 - 140 ozf.in	20 - 100 cN.m	Blue
TT250F/H	020155	4 - 20 lbf.in	50 - 250 cN.m	Red
TT500F/H	020157	8 - 40 lbf.in	100 - 500 cN.m	Green

Model	Graduation			Weight	
	American	S.I.	Drive	oz.	gm.
TT50F/H	2 ozf.in	2 cN.m	1/4" Female/Hex	6.7	190
TT100F/H	5 ozf.in	5 cN.m	1/4" Female/Hex	6.7	190
TT250F/H	0.5 lbf.in	10 cN.m	1/4" Female/Hex	16.4	465
TT500F/H	1 lbf.in	20 cN.m	1/4" Female/Hex	16.4	465

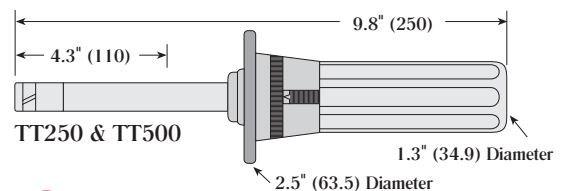
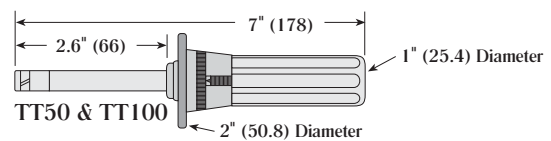

NOTE!

1/4" square drive models available upon request.

Larger models (TT250F/H and TT500F/H) supplied with removable sliding T-Bar.

Bits
See Pages
04.1 - 04.7



TorqueMate[®] Screwdriver

Electronic Torque Screwdriver

KEY FEATURES

- Accuracy \pm 1% of reading from 10% to 100% of full scale.
- Microprocessor controlled digital memory wrench for delivering precision torque, and storing & downloading torque readings.
- Ideal for torque measurement and auditing in R&D, QC, a lab, maintenance and production areas.
- RS-232 bi-directional USB cable for data transfer - Windows, MS Excel, SPC compatible. Additional download can be made in ASCII or binary format.
- Bi-directional
- Programmable pre-sets up to 99 pre-sets of torque can be programmed on screwdriver or uploaded from PC (software provided), all with individual minimum and maximum limits or percentage tolerances. Audible and visual alarms signal approach and achievement of preset torque values.
- Over torque warning system.
- Can store torque readings with a time and date stamp.
- Selectable languages and units of measurement.

SPECIFICATIONS

Operation Modes	Peak, Pre-set, Set, Recall, Upload, Clear, Date, Language, Units, Track, Backlite, Com
Units	ozf.in, lbf.in, lbf.ft, cN.m, N.m, kgf.cm, kgf.m
Alarms	Preset Value Approach, Fastener Overload, Range Overload, Mechanical Overload, Low Battery, Memory Full
Data Memory	2094 values
Power	4 x AA Batteries
Display Digits	Four
Languages	English, French, German, Italian, Portuguese & Spanish

Model	Item #	Torque Ranges	
		American	S.I.
TMS50	240160	7.1 - 70.8 ozf.in	5 - 50 cN.m
TMS350	240161	3.1 - 31 lbf.in	35 - 350 cN.m
TMS1700	240162	1.2 - 12 lbf.ft	1.7 - 17 N.m

Model	Square Drive	Length		Weight	
		in.	mm.	lbs.	kg.
TMS50	1/4"	6 2/3	170	1.6	.72
TMS350	1/4"	6 2/3	170	1.6	.72
TMS1700	1/4"	7 7/8	200	1.7	.77



BITS

A wide variety of bits available.
See Pages 4.1 - 4.7

**Hand Torque
Screwdrivers**



Screwdriver Kits

Internally and Externally Adjustable

Mountz provides a flexible screwdriver kit system that allows you the ability to select a hand screwdriver of your choice and package it with a tool kit. It's ideal for Field Service applications.



ERGO MICRO TORQUE DRIVERS

Torque Limiting Screwdrivers,
Externally Adjustable
See Page 01.2



PSE DRIVERS

Preset Torque Limiting Screwdrivers,
Internally Adjustable
See Page 01.6

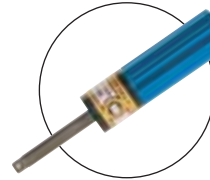

TLS DRIVERS

Preset Torque Limiting Screwdrivers,
Internally Adjustable
See Pages 01.3 & 01.4

Step 1

Select Hand Screwdriver:

- for Ergo Micro Torque Screwdrivers (see page 1.2)
- for PSE Screwdrivers (see page 1.6)
- for TLS Screwdrivers (see page 1.3)

Step 2

Select a Screwdriver Kit

NOTE!

Screwdriver Kits feature a blow-mold case with a locking cover and non-torque screwdriver handle, which can be removed and the Mountz torque screwdriver added. Each bit size has an individual marked location within the kit. See photo of kit on website.

SCREWDRIVER KIT #1 (Sockets & Bits Set - 55 pieces)
Item #125004

Contents in Kit:

- Extension Ratchet Screwdriver
- 1/4" Dr. Sockets: 3.2, 3.5, 4, 4.5, 5, 5.5, 6, 7, 8, 9, 10, 11, 12, 13mm
- Phillips Bits: PH0, PH1, PH2, PH3
- Pozi Bits: PZ0, PZ1, PZ2, PZ3
- Slotted Bits: 3, 4, 5, 5.5, 6.5, 7mm
- Star Tampered Bits: T10, T15, T20, T25, T30, T40
- Star Bits: T8, T9, T10, T15, T20, T25, T27, T30, T40
- Hex Bits: 2.5, 3, 4, 5, 6, 7mm
- Spline Bits: M4, M5, M6, M8
- 25mm Bit Adapter

SCREWDRIVER KIT #2 (Bits Set - 75 pieces)
Item #125005

Contents in Kit:

- Extension Ratchet Screwdriver
- Phillips Bits: PH0, PH1, PH2 (Qty 3), PH3
- Pozi Bits: PZ0, PZ1, PZ2 (Qty 3), PZ3
- Slotted Bits: 3, 4, 5.5, 6.5, 7, 8mm
- Star Bits: T8, T9, T10, T15, T20, T25, T27, T30, T35, T40
- Star Tampered Bits: T8, T9, T10, T15, T20, T25, T27, T30, T40
- Hex Bits: 1.5, 2, 2.5, 3, 4, 5, 6, 7mm
- Hex Tampered Bits: 2, 2.5, 3, 4, 5, 6mm
- Spanner Bits: 4, 6, 8, 10mm
- Tri-Wing Bits: #1, #2, #3, #4
- Torque Set: #6, #8, #10
- Robertson Bits: #0, #1, #2, #3
- Clutch Head: C1, C2, C3
- Spline Bits: M5, M6, M8
- Bit Adapter
- Hook Adapter

Accessories

Hand Torque Screwdrivers

ROTARY TORQUE UNITS - RTU

- Designed to be used "in-line" to limit torque for both manual and power-driven applications.
- CH models are suitable for chuck adaptation.
- Repeatability within $\pm 6\%$ of pre-set torque value.
- Reliable radial torque mechanism.
- The mechanism "slips-free" when the pre-set torque value is reached, eliminating overtightening. The mechanism then automatically resets.
- Pre-set the torque using a torque analyzer, see our torque analyzer catalog.
- Robust construction with corrosion-free finish.
- Non-length dependent and bi-directional.

Model	Item #	Torque Ranges		Max RPM	Input	Output
		lbf.in	S.I.			
RTU170	020584	0.9 - 15	10 - 170 cN.m	500	1/4" M/Hex	1/4" F/Hex
RTU170	020345	0.9 - 15	10 - 170 cN.m	500	3/8" F/Sq	3/8" M/Sq
RTU170CH	020346	0.9 - 15	10 - 170 cN.m	500	1/2" M/Hex	3/8" x 24*
RTU450	020585	9 - 40	1 - 4.5 N.m	500	1/4" M/Hex	1/4" F/Hex
RTU450	020347	9 - 40	1 - 4.5 N.m	500	3/8" F/Sq	3/8" M/Sq
RTU450CH	020348	9 - 40	1 - 4.5 N.m	500	1/2" M/Hex	3/8" x 24*
RTU1000	020586	36 - 88	4 - 10 N.m	250	1/4" M/Hex	1/4" F/Hex
RTU1000	020349	36 - 88	4 - 10 N.m	250	3/8" F/Sq	3/8" M/Sq
RTU1000CH	020350	36 - 88	4 - 10 N.m	250	1/2" M/Hex	3/8" x 24*



WARNING!

Not recommended for impact wrenches or pulse tools.

*UNF Thread

FREEWHEEL ADAPTERS

Transmit torque in one direction and "freewheel" in the reverse direction.

The "one way" feature is achieved using a roller clutch, which provides minimal backlash and drag.

Provided with a 1/4" male hex on one end and 1/4" female hex drive on the other end.

Easily adapts to EMT and TLS screwdrivers.

Absorbs unwanted shock loads.

Model: FWA-R
Torque: Clockwise
Freewheel: Counter Clockwise
Weight: 2.4 oz.
Item #20-A8842R

Model: FWA-L
Torque: Counter Clockwise
Freewheel: Clockwise
Weight: 2.4 oz.
Item #20-A8842L

1/4" MALE SQUARE DRIVE ADAPTER

Adapter can be used with any 1/4" Female Hex screwdriver to convert it into a 1/4" Male Square Drive screwdriver.

Item #020175

ERGONOMIC GRIPS

Molded from clear PVC.

Custom shaped to match screwdriver.

Provides softer, semi-cushioned feel to the operator.

Transparent PVC enables the screwdriver label, serial number and handle color to be clearly visible and readable through the grip.

Labels with preset and recalibration dates on the driver handle are protected.

Easily fitted using special P80 temporary lubricating emulsion (silicon free). When fitted, lubricant dries giving long-term grip even in moist conditions.

Model: Minor Grip
Weight (approx): 15 grams
Item #20-P19030

Model: Standard Grip
Weight (approx): 24 grams
Item #20-P19040

Model: P80 Lubricant
(100mL)
Item #20-A90220

MAGNETIZER / DEMAGNETIZER

Magnetize or demagnetize bits and parts instantly.

Item #120815

Hand Torque
Screwdrivers

RTU

RTU CH

Bits

See Pages
04.1 - 04.7

Fits TLS,
Minor &
Standard
See Page
01.4



Section 02

Assembly Power Tools

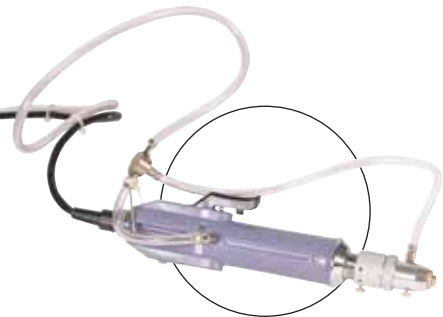

DC POWERED DRIVERS

These operate using a transformer (power supply) that supplies low voltage current.

See Pages 02.6 - 02.10

Mountz electric torque screwdrivers are designed with precision torque control and have become the state-of-the-art in innovative assembly. Low voltage motors combined with advanced electronics deliver torque control unmatched by any other production line driver. For sensitive and critical applications, there are electric screwdrivers available in Vacuum, Clean Room, and ESD style.

Vacuum

The screwdriver is fitted with a suction head that holds the screw on the bit, enabling the operator to pick it up with the tool itself. This is an effective, time saving device that works with most fasteners.

Clean Room

The screwdriver is equipped with a vacuum apparatus as well as a suction head to insure complete removal of fine particles generated during tightening process in clean rooms.

ESD

Do you believe in ghosts? If you are a manufacturing engineer, or find yourself involved anywhere within the production environment for microelectronics products, you should at least believe in the invisible reality of Electrostatic Discharge (ESD).

Any lapses in preventing the occurrence of electrostatic discharge can affect production yields, manufacturing costs, product quality, product reliability, reputation and profitability.

Static damage to electronic components can be realized as catastrophic failures or latent failures. Catastrophic failures are easier to detect and resolve. With this type of failure the part is "dead" and will not function. It may be costly to repair but is easy to manage. With latent failures the problem is much worse as the failure may not be detected in testing but is a "time bomb" waiting to happen. Since this product will get into the field and cause intermittent problems or failure in the field, it can be a much more costly problem.

Electrostatic discharge can be controlled in an electric screwdriver. ESD series screwdrivers feature a design using anti-electrostatic plastic material.

Electric Screwdrivers vs. Air Screwdrivers

Durability, cost, safety, accuracy, and flexibility are the strengths of an electric screwdriver as compared to air screwdrivers.

Electric screwdrivers are less expensive to operate and maintain. Electric drivers utilize simple serviceable brushes and lower voltage motors that resist burnout. Mountz electric power tools require normal maintenance associated with air tools but without all expensive plumbing, compressors, water separators, lubricators or filter/regulators needed to operate an air system.

Mountz electric drivers are inherently cleaner than air drivers, which emit oily exhaust. Air drivers are noisier than electric screwdrivers and less accurate. The air pressure fluctuates in an airline, which weakens the reliability and accuracy of air tools.

The flexibility of electric screwdrivers makes it easy to move an assembly operation by simply unplugging the tool and moving it. There is no hassle of dealing with plumbing, airlines, compressors and etc.



DIRECT PLUG-IN DRIVERS

Plugs directly into a power outlet without the need for a transformer.

See Pages 02.5 & 02.11



These charts are meant to be used as guidelines for setting the torque on the A, BF, BL, CL, E, EF, K, SS, VB, VZ Series electric screwdrivers. The drivers have a torque scale on the torque adjustment nut showing reference numbers. These numbers determine the approximate torque setting. Refer to the charts to determine the reference number setting for your torque requirement.

Torque Charts

Based on Torque Range of Electric Torque Screwdrivers

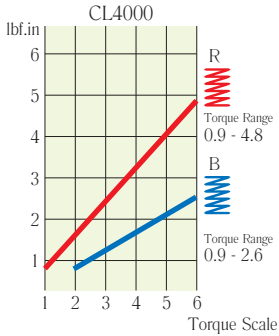

HOW TO READ THE TORQUE CHARTS

Torque ranges (lbf.in) approximate tightening torque, operated on 30V. Figures below each chart indicate scale setting on the tool. Some drivers have more than one spring. Select the appropriate spring to achieve the desired torque setting.

Example

Using the Red spring, when the torque adjustment nut is set to the #4 position, the CL-4000 will have an approximate tightening torque of 3 lbf.in.

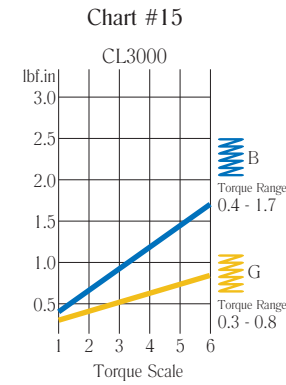
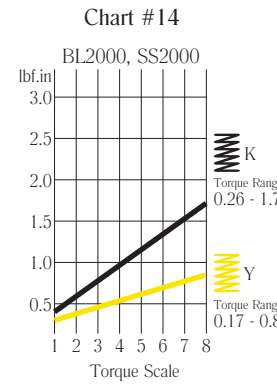
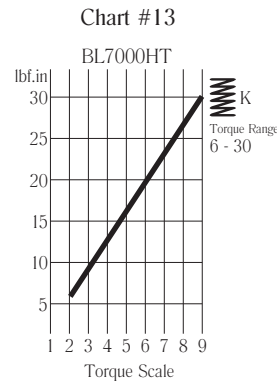
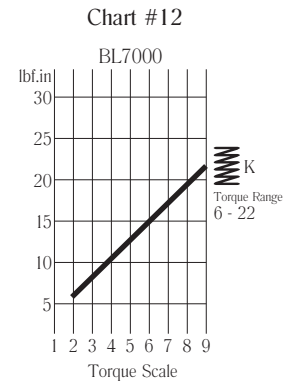
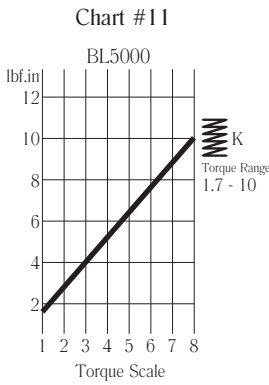
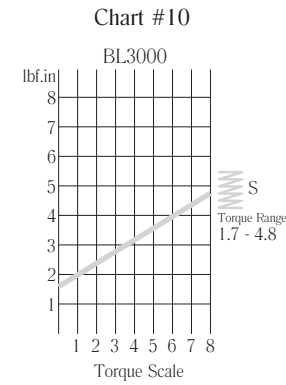
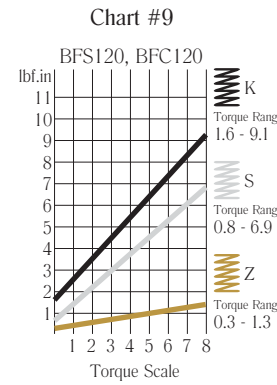
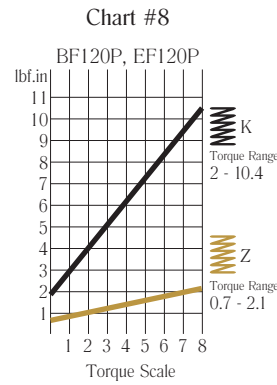
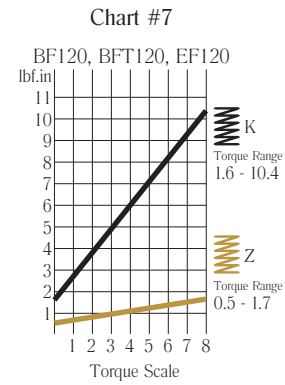
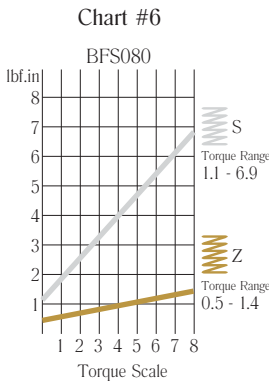
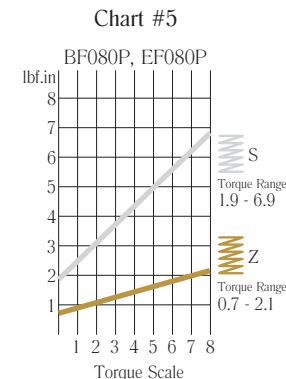
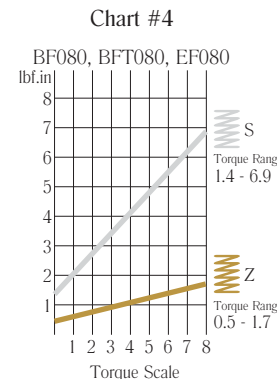
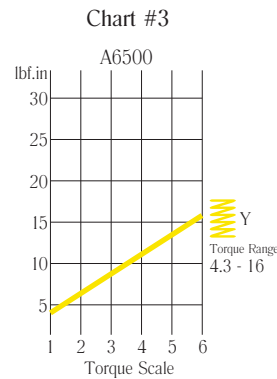
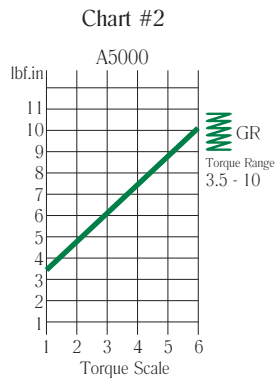
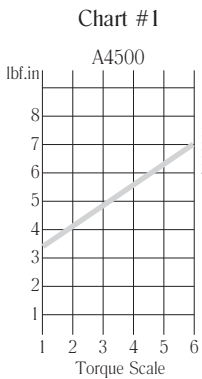
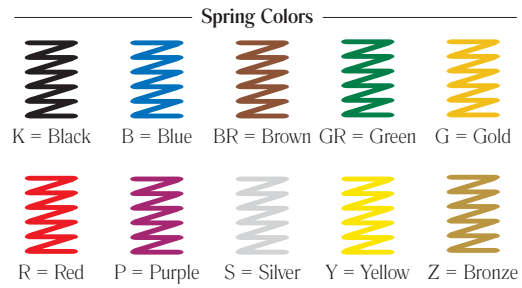

Chart #16

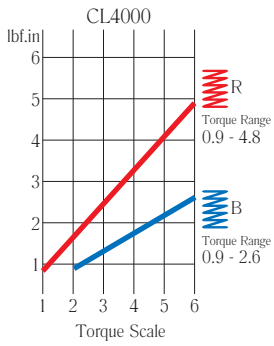

Chart #17

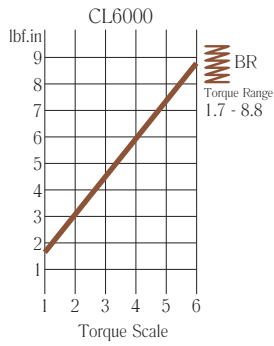

Chart #18

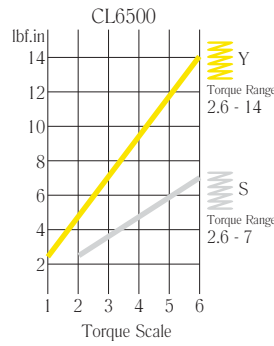

Chart #19

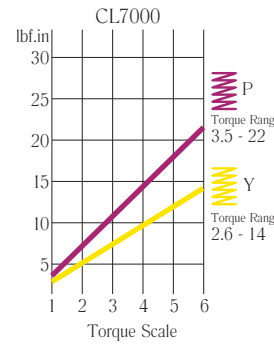

Chart #20

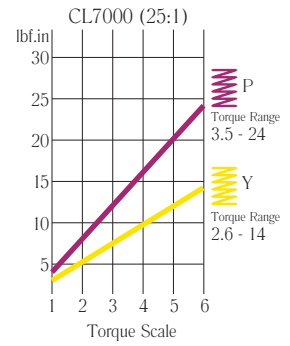

Chart #21

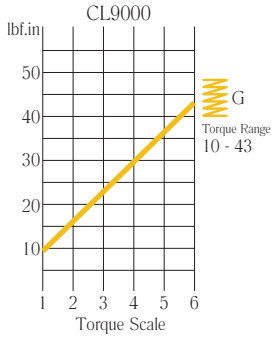

Chart #22

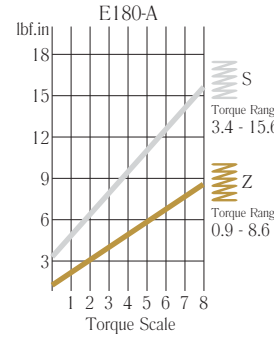

Chart #23

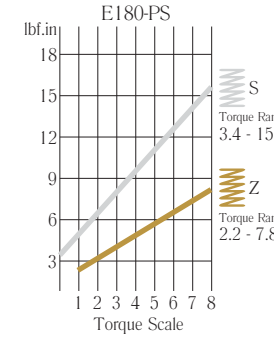

Chart #24

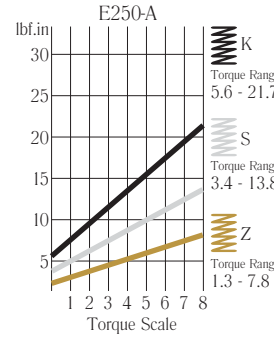

Chart #25

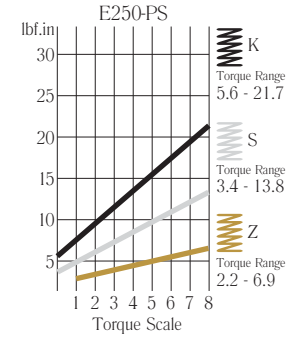

Chart #26

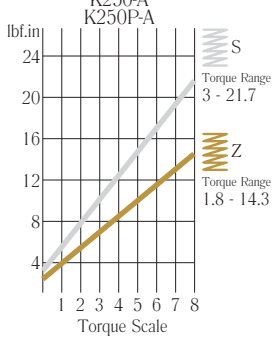

Chart #27

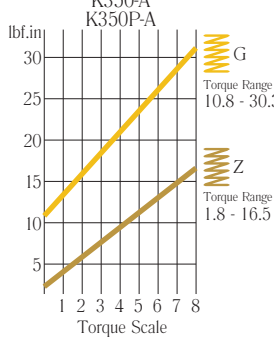

Chart #28

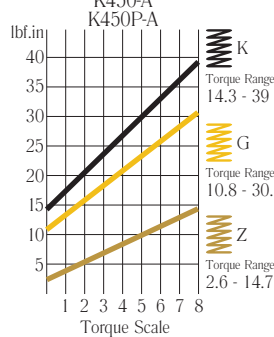

Chart #29

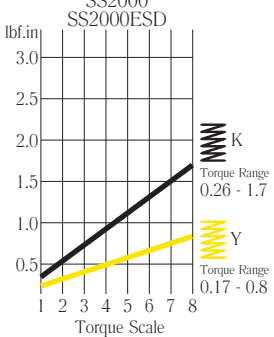

Chart #30

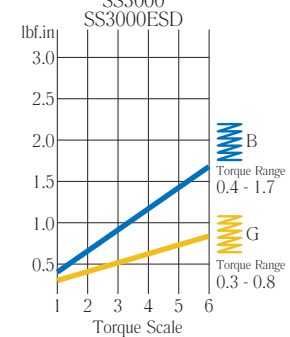

Chart #31

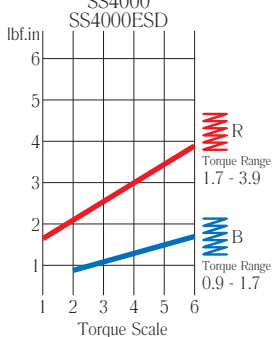

Chart #32

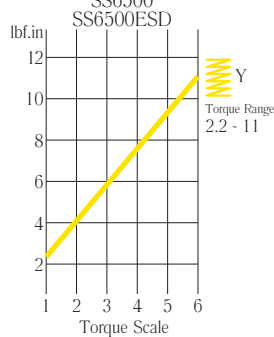

Chart #33

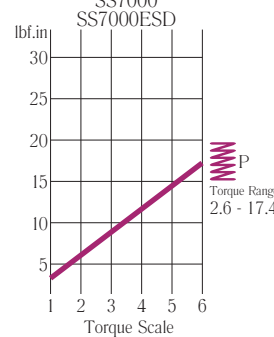

Chart #34

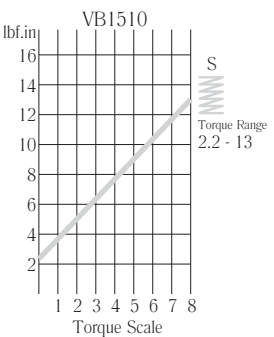

Chart #35

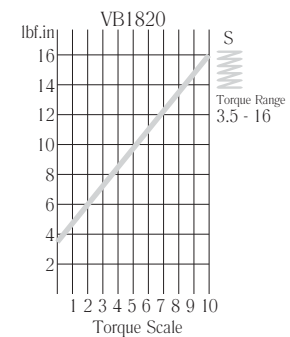

Chart #36

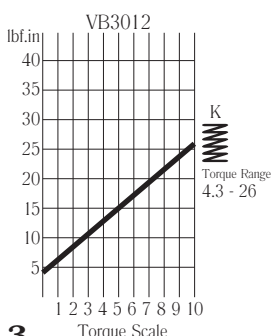

Chart #37

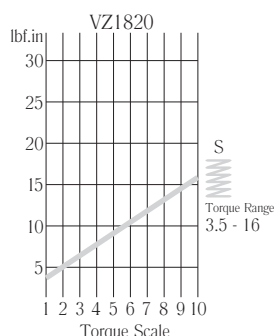

Chart #38

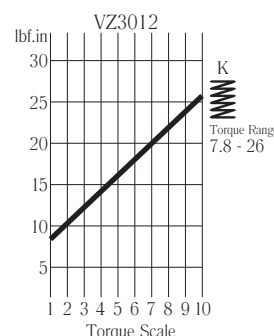
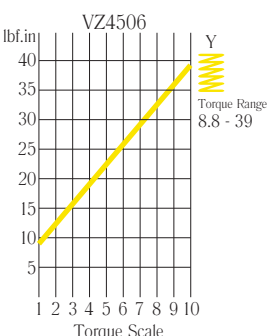

Chart #39



KEY FEATURES

Various models than range from 0.3 - 10.4 lbf.in.

High performance brushless motor design provides durability and reduces the standard maintenance costs for electric screwdrivers.

Designed for high production environments. Minimal heat build-up even when tool is operated continuously.

Over Heat Protection (OHP) and Over Current Protection (OCP) protect driver from damage or malfunction. Features a LED display that signals the tool status for the operator to view.

Can be connected with the Scout Screw Counter.

External torque adjustment scale.

Requires a transformer (power supply).

All models are ESD designed and prevent occurrence of electrostatic discharge, which improves production yields, manufacturing costs, product quality, product reliability, reputation and profitability.

Features driver lock.

SIX DRIVER MODELS

Standard: Available in Lever Start or Push-to-Start.

Standard Plus:

Available in Lever Start or Push-to-Start. Features a selectable Double Hit mode for soft joint applications and a selectable Soft Start mode (from 0.2 - 0.6 seconds).

Soft Stop: Available in Lever Start. Precision "Soft Stop" clutch prevents shock to sensitive assemblies like disk drives, plastics, electronics, etc.

Soft Stop Plus:

Available in Lever Start. Precision "Soft Stop" clutch prevents shock to sensitive assemblies like disk drives, plastics, electronics, etc. Features a selectable Double Hit mode for soft joint applications and a selectable Soft Start mode (from 0.2 - 0.6 seconds).

Time Control & Auto Reverse:

Available in Lever Start. Set the start, stop, and operating direction of the tool. Ideal for installation of helically wound inserts, light tapping or gauging applications.

Speed Control:

Available in Lever Start. Adjustable 300 - 700 RPM. Precision "Soft Stop" clutch prevents shock to sensitive assemblies like disk drives, plastics, electronics, etc.

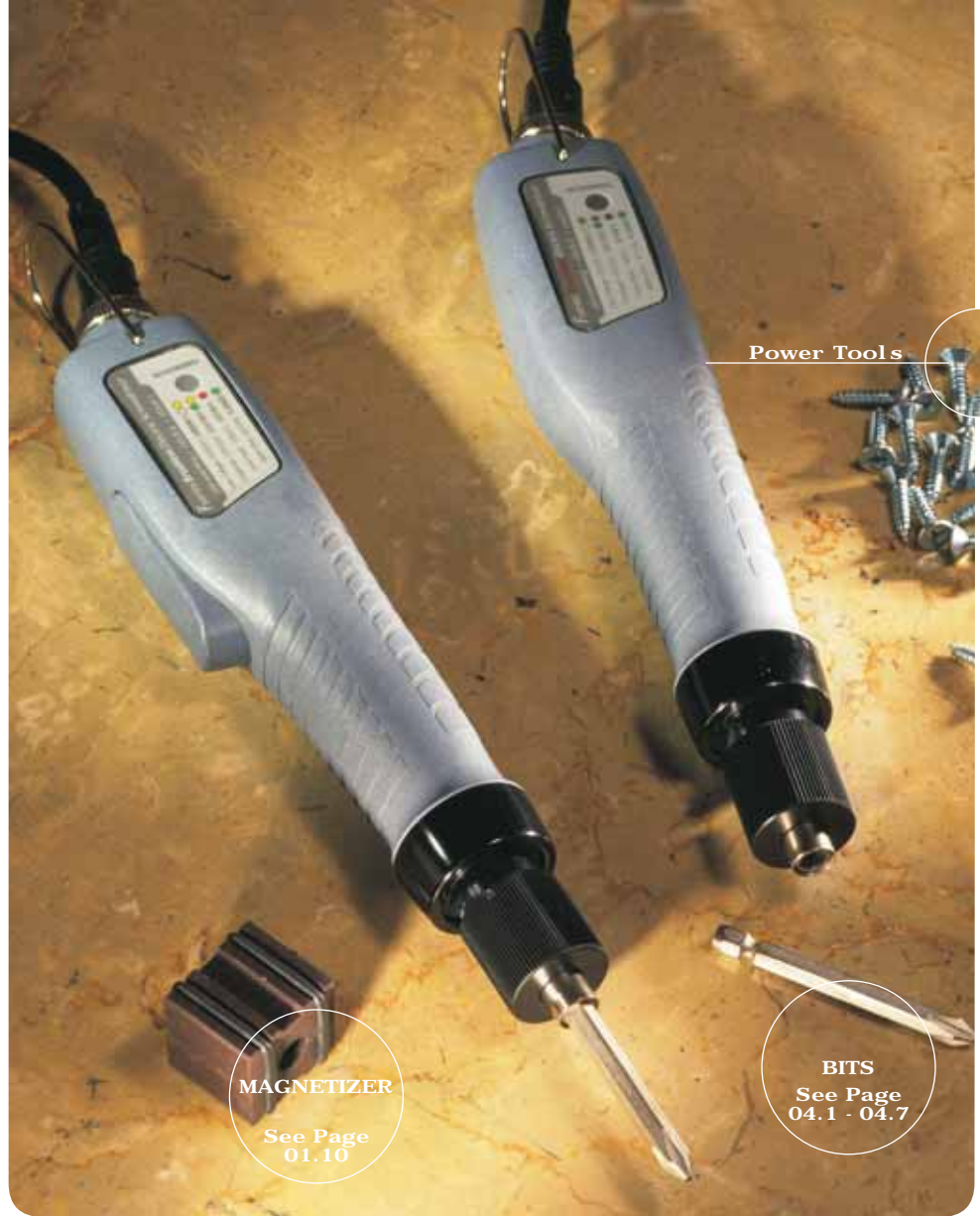

E-DRIV® BF-Series

Electric Torque Screwdrivers Brushless

STANDARD

Model	Item #	STANDARD PLUS		Driver Type	Torque Ranges		RPM	
		Model	Item #		lbf.in	cN.m	High	Low
BF080 ESD	145721	BF080 ESD Plus	145725	Lever Start	0.5 - 6.9	4.9 - 78.4	1000	670
BF080P ESD	145722	BF080P ESD Plus	145726	Push-to-Start	0.7 - 6.9	7.9 - 78.4	1000	670
BF120 ESD	145723	BF120 ESD Plus	145727	Lever Start	0.5 - 10.4	4.9 - 117.6	700	460
BF120P ESD	145724	BF120P ESD Plus	145728	Push-to-Start	0.7 - 10.4	7.9 - 117.6	700	460

SOFT STOP

Model	Item #	SOFT STOP PLUS		Driver Type	Torque Ranges		RPM	
		Model	Item #		lbf.in	cN.m	High	Low
BFS080 ESD	145729	BFS080 ESD Plus	145731	Lever Start	0.5 - 6.9	4.9 - 78.4	1000	670
BFS120 ESD	145730	BFS120 ESD Plus	145732	Lever Start	0.3 - 9.1	3 - 103	700	460

TIME CONTROL / AUTO REVERSE & SPEED CONTROL

Style	Model	Item #	Driver Type	Torque Ranges		RPM	
				lbf.in	cN.m	High	Low
Time Control & Auto Reverse	BFT080 ESD	145733	Lever Start	0.5 - 6.9	4.9 - 78.4	1000	670
Time Control & Auto Reverse	BFT120 ESD	145734	Lever Start	0.5 - 10.4	4.9 - 117.6	700	460
Speed Control	BFC120 ESD	145735	Lever Start	0.3 - 9.1	3 - 103	*	-

*Selectable speed on the High (30V) setting of the STC30+ Transformer with increments of 50 RPM's (9 increments from 300 - 700).

ALL BF-SERIES DRIVERS

Grip Dia.	Length	Drive Size	Weight
1 1/4"	8 2/3"	1/4" F/Hex	15.2 oz.



TORQUE COVER

(BF-Series models only)

Item # 145611

Protects from incidental or operator tampering of torque setting.

NOTE!

BF-Series "Plus" models have a Double Hit and Soft Start feature built-in. For torque reference chart, see pages 02.2 & 02.3

E-DRIV® E-Series

Electric Torque Screwdrivers
Direct Plug-In

Model	Driver Type	Item #	
		110V	220V
E180-A	Lever Start	145645	145646
E180-PS	Push-to-Start	145647	145648
E250-A	Lever Start	145649	145650
E250-PS	Push-to-Start	145651	145652

Model	Torque Ranges		
	lbf.in	cN.m	RPM
E180-A	0.9 - 15.6	10 - 176	1000
E180-PS	2.2 - 15.6	25 - 176	1000
E250-A	1.3 - 21.7	15 - 245	630
E250-PS	2.2 - 21.7	25 - 245	630

DIMENSIONS & WEIGHT

Model	Grip			
	Dia.	Length	Drive Size	Weight
E180-A	1 1/2"	10"	1/4" F/Hex	19.8 oz.
E180-PS	1 1/2"	10"	1/4" F/Hex	19.8 oz.
E250-A	1 1/2"	10"	1/4" F/Hex	19.8 oz.
E250-PS	1 1/2"	10"	1/4" F/Hex	19.8 oz.

Torque Covers

Protects from incidental or operator tampering of torque setting. Allows for color coding of specific torque values in production areas.

				
Black Item # 145654	Blue Item # 145655	Green Item # 145656	Gold Item # 145657	Gray Item # 145658

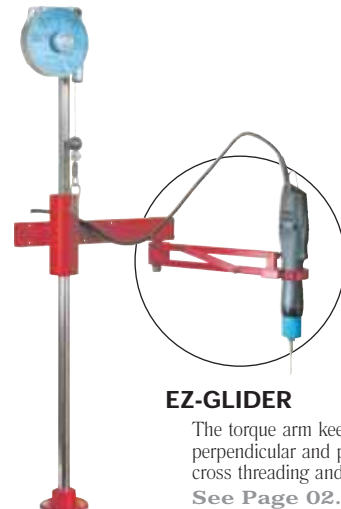

EZ-GLIDER

The torque arm keeps the tool perpendicular and prevents cross threading and side load.
See Page 02.25 & 02.26

Power Tools

KEY FEATURES

- Various models than range from 0.9 lbf.in to 21.7 lbf.in.
- Plugs directly into a power outlet. Does not require a separate power supply.
- Automatic power shut off once torque is achieved.
- Crafted to rest comfortably in the operators hand and reduces work fatigue with ergonomic handgrip.
- External torque adjustment scale.
- Push-to-Start and Lever models available.
- Duty cycle tool.
- 110V and 220V models.
- Power cord with a noise filter to reduce electronic noise (EMC).
- Lightweight.

NOTE!

For Torque Chart, see pages 02.2 - 02.3



POWER BITS

See Pages
04.2 & 04.3

EF-SERIES

Model	Driver Type	Item #	Torque Ranges	
			lbf.in	cN.m
EF080-A	Lever Start	145702	0.5 - 6.9	4.9 - 78.4
EF080-A ESD	Lever Start	145704	0.5 - 6.9	4.9 - 78.4
EF080P-A	Push-to-Start	145703	0.7 - 6.9	7.9 - 78.4
EF080P-A ESD	Push-to-Start	145705	0.7 - 6.9	7.9 - 78.4
EF120-A	Lever Start	145706	0.5 - 10.4	4.9 - 117.6
EF120-A ESD	Lever Start	145708	0.5 - 10.4	4.9 - 117.6
EF120P-A	Push-to-Start	145707	0.7 - 10.4	7.9 - 117.6
EF120P-A ESD	Push-to-Start	145709	0.7 - 10.4	7.9 - 117.6

Model	RPM		Grip Dia.	Length	Drive Size	Weight
	High	Low				
EF080-A	1000	670	1 1/4"	8 1/2"	1/4" F/Hex	11 oz.
EF080-A ESD	1000	670	1 1/4"	8 1/2"	1/4" F/Hex	11 oz.
EF080P-A	1000	670	1 1/4"	8 1/2"	1/4" F/Hex	11 oz.
EF080P-A ESD	1000	670	1 1/4"	8 1/2"	1/4" F/Hex	11 oz.
EF120-A	700	460	1 1/4"	8 1/2"	1/4" F/Hex	11 oz.
EF120-A ESD	700	460	1 1/4"	8 1/2"	1/4" F/Hex	11 oz.
EF120P-A	700	460	1 1/4"	8 1/2"	1/4" F/Hex	11 oz.
EF120P-A ESD	700	460	1 1/4"	8 1/2"	1/4" F/Hex	11 oz.

K-SERIES

Model	Driver Type	Item #	Torque Ranges	
			lbf.in	cN.m
K250-A	Lever Start	145660	1.8 - 21.7	19 - 245
K250-A ESD	ESD (Lever Start)	145665	1.8 - 21.7	19 - 245
K250P-A	Push-to-Start	145669	1.8 - 21.7	19 - 245
K250P-A ESD	ESD (Push-to-Start)	145673	1.8 - 21.7	19 - 245
K350-A	Lever Start	145661	1.8 - 30.3	19 - 343
K350-A ESD	ESD (Lever Start)	145666	1.8 - 30.3	19 - 343
K350P-A	Push-to-Start	145670	1.8 - 30.3	19 - 343
K350P-A ESD	ESD (Push-to-Start)	145674	1.8 - 30.3	19 - 343
K450-A	Lever Start	145662	2.6 - 39	30 - 441
K450-A ESD	ESD (Lever Start)	145667	2.6 - 39	30 - 441
K450P-A	Push-to-Start	145671	2.6 - 39	30 - 441
K450P-A ESD	ESD (Push-to-Start)	145675	2.6 - 39	30 - 441

Model	RPM		Grip Dia.	Length	Drive Size	Weight
	High	Low				
K250-A	1050	630	1 1/2"	10 1/4"	1/4" F/Hex	21.2 oz.
K250-A ESD	1050	630	1 1/2"	10 1/4"	1/4" F/Hex	21.2 oz.
K250P-A	1050	630	1 1/2"	10 1/4"	1/4" F/Hex	21.2 oz.
K250P-A ESD	1050	630	1 1/2"	10 1/4"	1/4" F/Hex	21.2 oz.
K350-A	750	460	1 1/2"	10 1/4"	1/4" F/Hex	21.2 oz.
K350-A ESD	750	460	1 1/2"	10 1/4"	1/4" F/Hex	21.2 oz.
K350P-A	750	460	1 1/2"	10 1/4"	1/4" F/Hex	21.2 oz.
K350P-A ESD	750	460	1 1/2"	10 1/4"	1/4" F/Hex	21.2 oz.
K450-A	550	330	1 1/2"	10 1/4"	1/4" F/Hex	21.2 oz.
K450-A ESD	550	330	1 1/2"	10 1/4"	1/4" F/Hex	21.2 oz.
K450P-A	550	330	1 1/2"	10 1/4"	1/4" F/Hex	21.2 oz.
K450P-A ESD	550	330	1 1/2"	10 1/4"	1/4" F/Hex	21.2 oz.

NOTE!

For Torque Chart, see pages 02.2 & 02.3

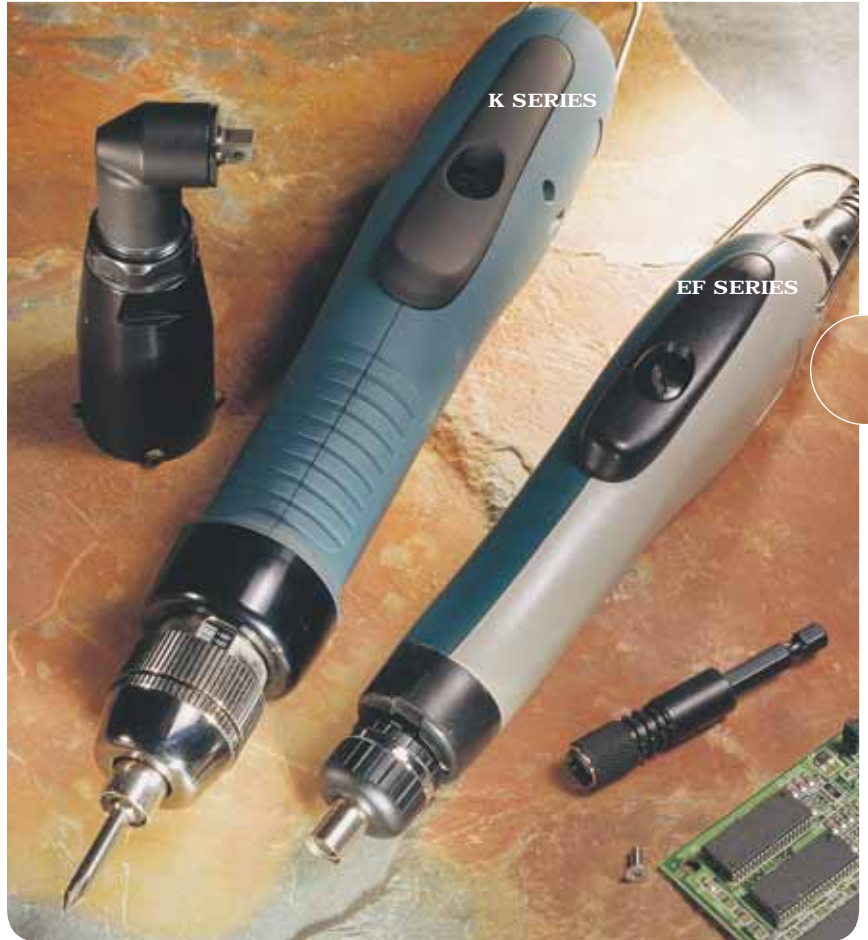

E-DRIV[®] EF & K-Series

Electric Torque Screwdrivers Low Voltage DC

KEY FEATURES

Various models that range from 0.5 lbf.in to 39 lbf.in.

Rugged production tools designed to increase productivity and enhance product quality through precision torque control and user comfort.

Ensures accuracy in fastening with precision automatic shut-off clutch once preset torque is achieved.

External torque adjustment scale.

Available in Lever, Push-to-Start, and ESD models.

Requires a transformer (power supply).



MOUNTZ RIGHT ANGLE ADAPTER

See Page 02.19



TRANSFORMER

A transformer is required for the drivers.

See Pages 02.17 & 02.18



TORQUE COVER

Item #145615 (for K-Series)

Protects the tool from incidental or operator tampering of torque setting.

Item #145700

For EF-Series (EF080 and EF120 models only.)

etorque.com

ISO 9001 and ISO 17025 Company

EF-Series & K-Series

02.6

SS-Series

Electric Torque Screwdrivers Low Voltage DC

KEY FEATURES

Various models that range from 0.17 lbf.in - 17.4 lbf.in.

Precision "Soft-Stop" clutch prevents shock to sensitive assemblies like disk drives, plastics, electronics, etc.

Ergonomically designed clutch and body case reduces impact and vibration transmitted in the screw fastening process.

Low voltage requirement offers superior life and safe operation.

Requires a Transformer (power supply).

External torque adjustment scale.

One way clutch - direct drive in the counter-clockwise direction for easy removal of tightened fasteners.

Available in ESD (see page 02.8), Clean Room, Push-to-Start, Vacuum, and Lever models.



Model	Driver Type	Item #	Torque Ranges	
			lbf.in	cN.m
SS2000	Lever Start	144022	0.17 - 1.7	2 - 20
SSQ2000	Vacuum*	144105	0.17 - 1.7	2 - 20
SS3000	Lever Start	144031	0.3 - 1.7	3 - 20
SS3000PS	Push-to-Start	144032	0.3 - 1.7	3 - 20
SSQ3000	Vacuum*	144033	0.3 - 1.7	3 - 20
SSQ3000CR	Vacuum/Clean Room*	144034	0.3 - 1.7	3 - 20
SS4000X	Lever Start	144217	0.9 - 3.9	10 - 45
SS4000XPS	Push-to-Start	144222	0.9 - 3.9	10 - 45
SSQ4000X	Vacuum*	144219	0.9 - 3.9	10 - 45
SSQ4000XCR	Vacuum/Clean Room*	144224	0.9 - 3.9	10 - 45
SS6500X	Lever Start	144368	2.2 - 11	25 - 130
SSQ6500X	Vacuum*	144372	2.2 - 11	25 - 130
SSQ6500XCR	Vacuum/Clean Room*	144369	2.2 - 11	25 - 130
SS7000X	Lever Start	144236	2.6 - 17.4	30 - 200
SSQ7000X	Vacuum*	144238	2.6 - 17.4	30 - 200
SSQ7000XCR	Vacuum/Clean Room*	144240	2.6 - 17.4	30 - 200

*All Vacuum and Clean Room models are lever start.

Model	RPM		Grip Dia.	Length	Drive Size	Weight
	30VDC	20VDC				
SS2000	680	490	1"	6 1/2"	4mm HIOS	7.1 oz.
SSQ2000	680	490	1"	6 1/2"	4mm HIOS	7.4 oz.
SS3000	1000	670	1 1/4"	7 1/4"	4mm HIOS	12.5 oz.
SS3000PS	1000	670	1 1/4"	7 1/4"	4mm HIOS	13.8 oz.
SSQ3000	1000	670	1 1/4"	7 1/4"	4mm HIOS	12.8 oz.
SSQ3000CR	1000	670	1 1/4"	7 1/4"	4mm HIOS	12.8 oz.
SS4000X	1000	690	1 1/4"	7 3/4"	1/4" F/Hex	14.1 oz.
SS4000XPS	1000	690	1 1/4"	7 3/4"	1/4" F/Hex	15.9 oz.
SSQ4000X	1000	690	1 1/4"	7 3/4"	1/4" F/Hex	14.4 oz.
SSQ4000XCR	1000	690	1 1/4"	7 3/4"	1/4" F/Hex	14.4 oz.
SS6500X	900	600	1 1/2"	9 1/4"	1/4" F/Hex	23.3 oz.
SSQ6500X	900	600	1 1/2"	9 1/4"	1/4" F/Hex	23.6 oz.
SSQ6500XCR	900	600	1 1/2"	9 1/4"	1/4" F/Hex	23.6 oz.
SS7000X	750	-	1 1/2"	10"	1/4" F/Hex	26.5 oz.
SSQ7000X	750	-	1 1/2"	10"	1/4" F/Hex	26.8 oz.
SSQ7000XCR	750	-	1 1/2"	10"	1/4" F/Hex	26.8 oz.



TRANSFORMER

A transformer is required for the SS-Series drivers.
See Pages 02.17 & 02.18

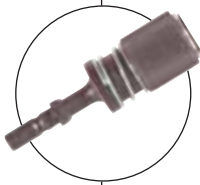

HIOS to HEX ADAPTER

See Page 02.19

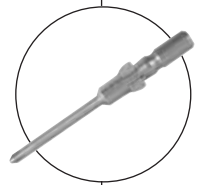

BITS

Power Bits
See Pages 04.2 & 04.3

HIOS Bits (shown)
See Page 04.6



ACCESSORIES

Pistol Grip (shown)
Push-to-Start Adapter
Right Angle Adapter
Vacuum Adapter Kits
See Pages 02.19 & 02.20



NOTE!

For Torque Chart, see pages 02.2 - 02.3

ESD-Series

Electric Torque Screwdrivers Low Voltage DC

KEY FEATURES

Various models that range from 0.17 lbf.in to 17.4 lbf.in.

Casing designed to prevent electrostatic discharge (ESD). Surface resistance 10^4 Ohms.

Preventing the occurrence of electrostatic discharge can improve production yields, manufacturing costs, product quality, product reliability, reputation, and profitability.

Precision "Soft Stop" clutch prevents shock to sensitive assemblies.

Ergonomically designed clutch and body case that reduces impact and vibration transmitted in the screw fastening process.

Requires a Transformer (power supply).

External torque adjustment scale.

One way clutch - direct drive in the counter-clockwise direction for easy removal of tightened fasteners.

Available in Clean Room, Vacuum, and Lever models.

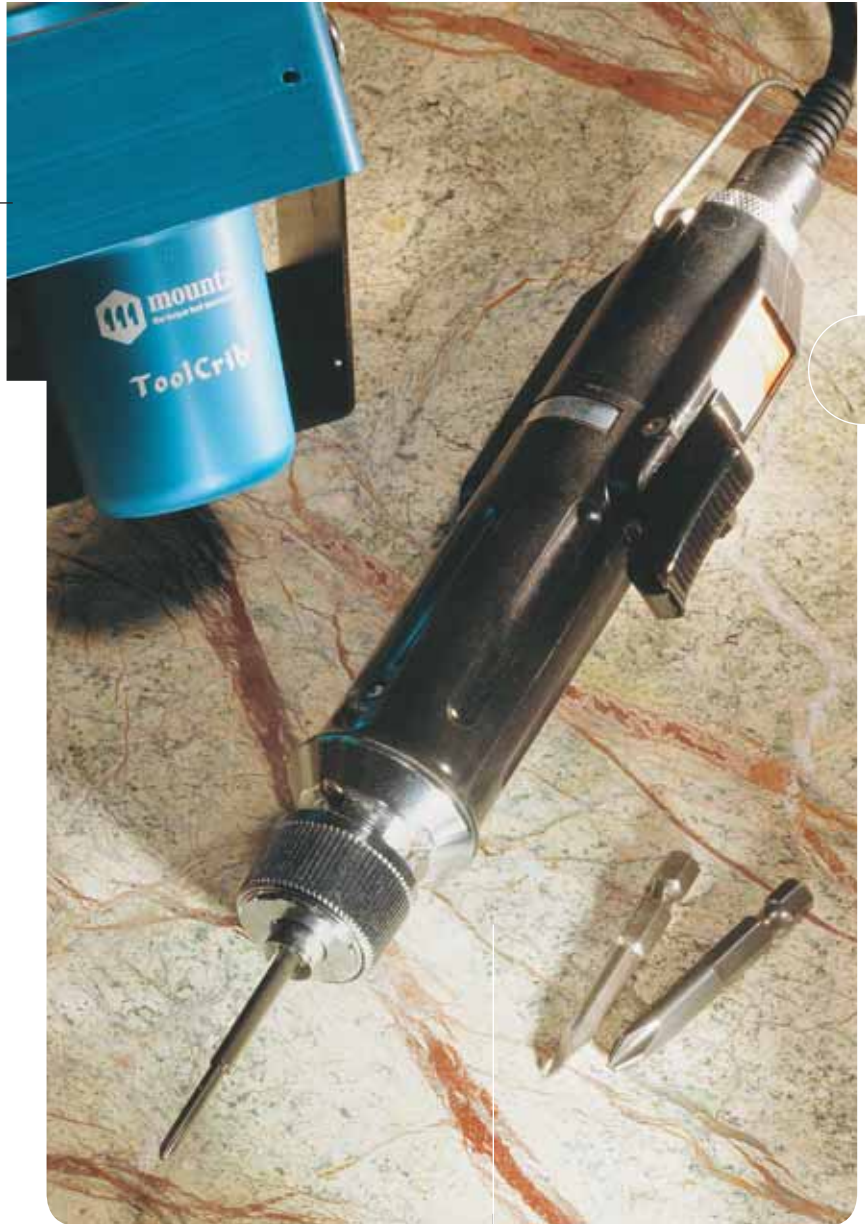

Model	Driver Type	Item #	Torque Ranges	
			lbf.in	cN.m
SS2000-ESD	Lever Start	144104	0.17 - 1.7	2 - 20
SSQ2000CR-ESD	Vacuum/Clean Room*	144035	0.17 - 1.7	2 - 20
SS3000-ESD	Lever Start	144233	0.3 - 1.7	3 - 20
SS3000-ESD	Vacuum*	144252	0.3 - 1.7	3 - 20
SSQ3000CR-ESD	Vacuum/Clean Room*	144259	0.3 - 1.7	3 - 20
SS4000X-ESD	Lever Start	144234	0.9 - 3.9	10 - 45
SSQ4000X-ESD	Vacuum*	144254	0.9 - 3.9	10 - 45
SSQ4000XCR-ESD	Vacuum/Clean Room*	144263	0.9 - 3.9	10 - 45
SS6500X-ESD	Lever Start	144249	2.2 - 11	25 - 130
SSQ6500X-ESD	Vacuum*	144230	2.2 - 11	25 - 130
SSQ6500XCR-ESD	Vacuum/Clean Room*	144226	2.2 - 11	25 - 130
SS7000X-ESD	Lever Start	144231	2.6 - 17.4	30 - 200
SSQ7000X-ESD	Vacuum*	144258	2.6 - 17.4	30 - 200
SSQ7000XCR-ESD	Vacuum/Clean Room*	144262	2.6 - 17.4	30 - 200

*All Vacuum and Clean Room models are lever start.

Model	RPM		Grip Dia.	Length	Drive Size	Weight
	30VDC	20VDC				
SS2000-ESD	680	490	1"	6 1/2"	4mm HIOS	7.1 oz.
SSQ2000CR-ESD	680	490	1"	6 1/2"	4mm HIOS	7.4 oz.
SS3000-ESD	1000	670	1 1/4"	7 1/4"	4mm HIOS	12.5 oz.
SSQ3000-ESD	1000	670	1 1/4"	7 1/4"	4mm HIOS	12.8 oz.
SSQ3000CR-ESD	1000	670	1 1/4"	7 1/4"	4mm HIOS	12.8 oz.
SS4000X-ESD	1000	690	1 1/4"	7 3/4"	1/4" F/Hex	14.1 oz.
SSQ4000X-ESD	1000	690	1 1/4"	7 3/4"	1/4" F/Hex	14.4 oz.
SSQ4000XCR-ESD	1000	690	1 1/4"	7 3/4"	1/4" F/Hex	14.4 oz.
SS6500X-ESD	900	600	1 1/2"	9 1/4"	1/4" F/Hex	23.3 oz.
SSQ6500X-ESD	900	600	1 1/2"	9 1/4"	1/4" F/Hex	23.6 oz.
SSQ6500XCR-ESD	900	600	1 1/2"	9 1/4"	1/4" F/Hex	23.6 oz.
SS7000X-ESD	750	-	1 1/2"	10"	1/4" F/Hex	26.5 oz.
SSQ7000X-ESD	750	-	1 1/2"	10"	1/4" F/Hex	26.8 oz.
SSQ7000XCR-ESD	750	-	1 1/2"	10"	1/4" F/Hex	26.8 oz.



TRANSFORMER

A transformer is required for ESD-Series drivers.

See Pages 02.17 & 02.18



TOOL CRIB

Holds driver for easy access, mounts in a variety of positions and rotates to 8 settings.

See Pages 02.19 & 02.20

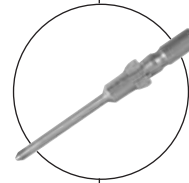

BITS

Power Bits

See Pages 04.2 & 04.3

HIOS Bits (shown)

See Page 04.6



ACCESSORIES

Vacuum Adapter Kits
See Page 02.21



NOTE!

For Torque Chart, see pages 02.2 & 02.3

A-Series

High Speed Electric Screwdrivers
Low Voltage DC



KEY FEATURES

Various models that range from 3.5 lbf.in to 16 lbf.in.

Designed with a powerful, high speed motor to increase productivity and efficiency.

A-Series drivers utilize a samarium cobalt magnet in the motor to achieve higher speeds than the comparable CL-Series drivers. Size and weight increases are minimal.

Ensures accuracy in fastening with precision automatic shut-off clutch once preset torque is achieved.

External torque adjustment scale.

Available with Lever Start and Push-to-Start models.

Requires a Transformer (power supply).

ESD models available upon request.

Model	Driver Type	Item #	Torque Ranges	
			lbf.in	cN.m
A4500	Lever Start	144112	3.5 - 7	40 - 80
A4500X	Lever Start	144113	3.5 - 7	40 - 80
A5000	Lever Start	144055	3.5 - 10	40 - 120
A5000X	Lever Start	144056	3.5 - 10	40 - 120
A6500X	Lever Start	144124	4.3 - 16	50 - 180
A6500PS	Push-to-Start	144118	4.3 - 16	50 - 180

Model	RPM		Grip Dia.	Length	Drive Size	Weight
	30VDC	20VDC				
A4500	1700	1200	1 1/4"	7 3/4"	4mm HIOS	16 oz.
A4500X	1700	1200	1 1/4"	7 3/4"	1/4" F/Hex	16 oz.
A5000	1000	700	1 1/4"	7 3/4"	4mm HIOS	16 oz.
A5000X	1000	700	1 1/4"	7 3/4"	1/4" F/Hex	16 oz.
A6500X	1700	-	1 1/2"	9"	1/4" F/Hex	24 oz.
A6500PS	1700	-	1 1/2"	9"	1/4" F/Hex	24 oz.

NOTE!

For torque reference chart, see page 02.3

For Torque Analyzers, ask for our "Torque Analyzer & Torque Measurement" catalog.



TRANSFORMER

A transformer is required for the A-Series drivers.

See Pages 02.17 & 02.18



HIOS to HEX ADAPTER

See Page 02.19

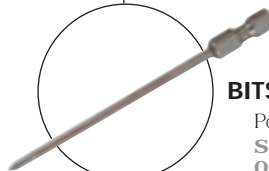

BITS

Power Bits (shown)
See Pages 04.2 & 04.3

HIOS Bits
See Page 04.6



ACCESSORIES

Push-to-Start Adapter (shown)
Right Angle Adapter
Pistol Grip
Vacuum Adapter Kits

See Pages 02.19 - 02.21

CL-Series

Electric Torque Screwdrivers Low Voltage DC



KEY FEATURES

- Various models that range from 0.17 lbf.in to 69 lbf.in.
- Designed for heavy-duty production and delivers reliability and precision torque.
- Ensures accuracy in fastening with precision automatic shut-off clutch once preset torque is achieved.
- External torque adjustment scale.
- Low voltage requirements offer superior life and safe operation.
- Available in Lever, Push-to-Start and ESD models.
- Requires a Transformer (power supply).
- CL9000 provided with a shockless reaction stand to provide precise torque control and to eliminate torque reaction to the operator.

Model	Driver Type	Item #	Torque Ranges		RPM		Grip Diameter	Length	Drive Size	Weight
			lbf.in	cN.m	30 VDC	20 VDC				
CL2000	Lever Start	144103	0.17 - 1.7	2 - 20	680	490	1"	6 1/2"	4mm HIOS	7 oz.
CL2000-ESD	ESD (Lever Start)	144097	0.17 - 1.7	2 - 20	680	490	1"	6 1/2"	4mm HIOS	7 oz.
CL3000	Lever Start	144106	0.3 - 1.7	3 - 20	1000	670	1 1/4"	7 1/4"	4mm HIOS	12.4 oz.
CL3000PS	Push-to-Start	144107	0.3 - 1.7	3 - 20	1000	670	1 1/2"	7 1/4"	4mm HIOS	13.8 oz.
CL3000-ESD	ESD (Lever Start)	144098	0.3 - 1.7	3 - 20	1000	670	1 1/4"	7 1/4"	4mm HIOS	12.4 oz.
CL4000	Lever Start	144110	0.9 - 4.8	10 - 55	1000	690	1 1/4"	7 3/4"	1/4" Female/Hex	13.4 oz.
CL4000	Lever Start	144111	0.9 - 4.8	10 - 55	1000	690	1 1/4"	7 3/4"	4mm HIOS	13.4 oz.
CL4000PS	Push-to-Start	144108	0.9 - 4.8	10 - 55	1000	690	1 1/2"	7 3/4"	1/4" Female/Hex	15.2 oz.
CL4000-ESD	ESD (Lever Start)	144099	0.9 - 4.8	10 - 55	1000	690	1 1/4"	7 3/4"	1/4" Female/Hex	13.4 oz.
CL6000	Lever Start	144116	1.7 - 8.8	20 - 100	800	500	1 1/2"	8 5/8"	1/4" Female/Hex	21.2 oz.
CL6000PS	Push-to-Start	144119	1.7 - 8.8	20 - 100	800	500	1 1/2"	8 5/8"	1/4" Female/Hex	21.2 oz.
CL6000-ESD	ESD (Lever Start)	144320	1.7 - 8.8	20 - 100	800	500	1 1/2"	8 5/8"	1/4" Female/Hex	21.2 oz.
CL6500	Lever Start	144121	2.6 - 14	30 - 160	900	600	1 1/2"	9 1/4"	1/4" Female/Hex	23.3 oz.
CL6500PS	Push-to-Start	144120	2.6 - 14	30 - 160	900	600	1 1/2"	9 1/4"	1/4" Female/Hex	23.3 oz.
CL6500-ESD	ESD (Lever Start)	144100	2.6 - 14	30 - 160	900	600	1 1/2"	9 1/4"	1/4" Female/Hex	23.3 oz.
CL7000	Lever Start	144126	2.6 - 22	30 - 250	750	-	1 1/2"	10"	1/4" Female/Hex	26.5 oz.
CL7000PS	Push-to-Start	144125	2.6 - 22	30 - 250	750	-	1 1/2"	10"	1/4" Female/Hex	26.5 oz.
CL7000-ESD	ESD (Lever Start)	144101	2.6 - 22	30 - 250	750	-	1 1/2"	10"	1/4" Female/Hex	26.5 oz.
*CL7000	Lever Start	144182	2.6 - 24	30 - 271	550	-	1 1/2"	10"	1/4" Female/Hex	26.5 oz.
CL9000PS	Push-to-Start	144130	10 - 43	120 - 500	530	-	2"	10"	1/4" Female/Hex	46 oz.
**CL9000PS-HT	Push-to-Start	144265	17 - 69	192 - 780	350	-	2"	10"	1/4" Female/Hex	46 oz.



TRANSFORMER

A transformer is required for the CL-Series drivers.
See Pages
02.17 & 02.18



ACCESSORIES

Coiled Cord (shown)
Right Angle Adapter
Pistol Grip
Push-to-Start Adapter
Vacuum Adapter Kits
See Pages
02.19 & 02.20



Power & HIOS Bits
See Pages
04.2 & 04.3 & 04.6



NOTE!

For Torque Chart, see pages 02.2 & 02.3
* 25:1 gear ratio allows increased torque output at lower RPM's.
** 36:1 gear ratio allows increased torque output at lower RPM's.
CL3000 and CL4000 models need a torque adjustment nut
Item #060012 and set screw Item #220100 to preset driver to a specific torque.

VZ-Series

Electric Torque Screwdrivers Direct Plug-In

KEY FEATURES

- Various models that range from 3.5 - 39 lbf.in.
- Plugs directly into a power outlet. Separate power supply not required.
- Positive auto shut-off.
- Ergonomic hand grip.
- Push-to-Start and Lever operated styles available.
- Duty cycle tool.
- 120 VAC, 10 foot power cord.
- External torque adjustment scale.

Model	Driver Type	Item #	Torque Ranges	
			lbf.in	cN.m
VZ1820	Lever Start	144350	3.5 - 16	40 - 180
VZ1820PS	Push-to-Start	144351	3.5 - 16	40 - 180
VZ3012	Lever Start	144352	7.8 - 26	90 - 300
VZ3012PS	Push-to-Start	144353	7.8 - 26	90 - 300
VZ4506	Lever Start	144378	8.8 - 39	100 - 450
VZ4506PS	Push-to-Start	144377	8.8 - 39	100 - 450

Model	RPM	Grip Dia.	Length	Drive Size	Weight
VZ1820	2000	1 1/2"	11"	1/4" Female/Hex	24 oz.
VZ1820PS	2000	1 1/2"	11"	1/4" Female/Hex	24 oz.
VZ3012	1200	1 1/2"	11"	1/4" Female/Hex	24 oz.
VZ3012PS	1200	1 1/2"	11"	1/4" Female/Hex	24 oz.
VZ4506	600	1 1/2"	11"	1/4" Female/Hex	24 oz.
VZ4506PS	600	1 1/2"	11"	1/4" Female/Hex	24 oz.



NOTE!

For Torque Chart, see pages 02.2 & 02.3

VZ ACCESSORIES



HAND SUPPORT RING

Reduces strain on the operator. Allows operator to increase downward pressure without slipping. Ideal for Push-to-Start models.
Item #144357



TORQUE ADJ. COVER

Protects the VZ-Series from incidental operator tampering of torque setting.
Item #144358



PISTOL GRIP ATTACHMENT

Provides comfort and versatility.
Lever Start Models
Item #144355
Push-to-Start Models
Item #144354



RIGHT ANGLE ADAPTER

For Lever Start models. Ensures perfect results for hard to reach joints.
Item #144365



VACUUM PICKUP ATTACHMENT

Provides increased efficiency.
Item #144356



SHOCKLESS REACTION STAND

Item #144362
For Lever Start models. Assists with operator safety.
Item #144363
For Push-to-Start models.



MAGNETIZER/DEMAGNETIZER

Magnetize and demagnetize bits and parts instantly.
See Accessories
Page 02.19



BITS

Power Bits
See Pages
04.2 & 04.3



VB-Series

Brushless Electric Torque Screwdrivers Direct Plug-In

Model	Driver Type	Item #	Torque Ranges	
			lbf.in	cN.m
VB1510	Lever Start	144280	2.2 - 13	25 - 150
VB1510PS	Push-to-Start	144281	2.2 - 13	25 - 150
VB1820	Lever Start	144282	3.5 - 16	40 - 180
VB1820PS	Push-to-Start	144283	3.5 - 16	40 - 180
VB3012	Lever Start	144284	4.3 - 26	50 - 300
VB3012PS	Push-to-Start	144285	4.3 - 26	50 - 300

Model	RPM	Grip Diameter	Length	Drive Size	Weight
VB1510	970	1 1/4"	10"	1/4" Female/Hex	18.6 oz.
VB1520PS	970	1 1/4"	10"	1/4" Female/Hex	18.6 oz.
VB1820	2000	1 1/2"	11 1/4"	1/4" Female/Hex	26.5 oz.
VB1820PS	2000	1 1/2"	11 1/4"	1/4" Female/Hex	26.5 oz.
VB3012	1200	1 1/2"	11 1/4"	1/4" Female/Hex	26.5 oz.
VB3012PS	1200	1 1/2"	11 1/4"	1/4" Female/Hex	26.5 oz.

NOTE!

For Torque Chart, see pages 02.2 & 02.3

KEY FEATURES

Various models that range from 2.2 lbf.in to 26 lbf.in.

High performance brushless motor design provides durability and reduces the standard maintenance costs for electric drivers.

Designed for high production environments. Minimal heat build-up even when tool is operated continuously.

Plugs directly into a power outlet. Separate power supply not required.

Positive auto shut-off.

Push-to-Start and Lever operated styles available.

Duty cycle tool.

120 VAC, 10 foot power cord.

External torque adjustment scale.

ACCESSORIES

Pistol Grip Attachment (Push-to-Start Models)
Item #144274

Right Angle Adapter for Lever Start Models
Item #144365

Hand Support Ring **Item #144357**

Accessories
See Pages
02.19 - 02.20



TOOL CRIB

Prevents broken or dropped tools. Reduces tool bench clutter. Easy operator access. Mounts in a variety of positions on the work bench or the production line. The flexible ToolCrib can rotate to 8 locations. Hole at the bottom of ToolCrib allows for a bit to pass through. Crafted with durable aluminum.
Item #064000



MAGNETIZER / DEMAGNETIZER

Magnetize or demagnetize bits and parts instantly.
Item #120815



BALANCERS

Provides easy handling for operators that work with tools for long, continuous hours.
See Page 02.15



Example #1:
BFA-Series model with Scout

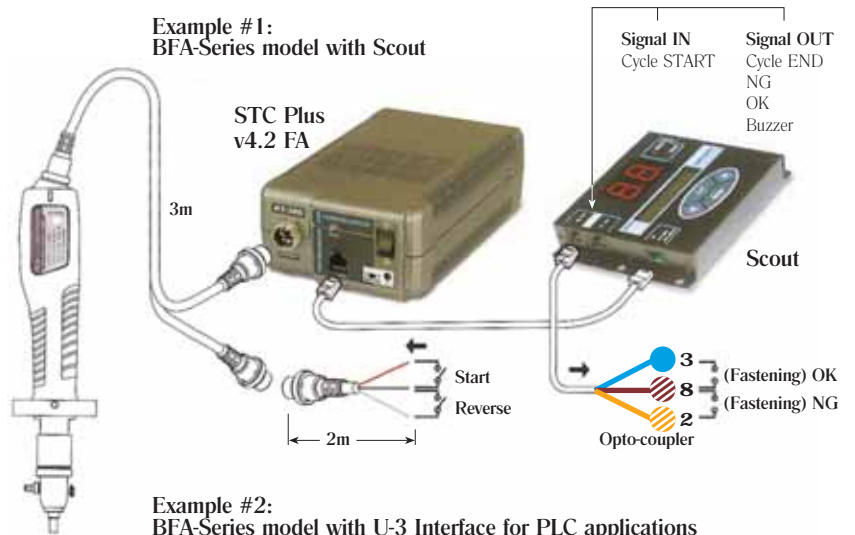

Example #2:
BFA-Series model with U-3 Interface for PLC applications

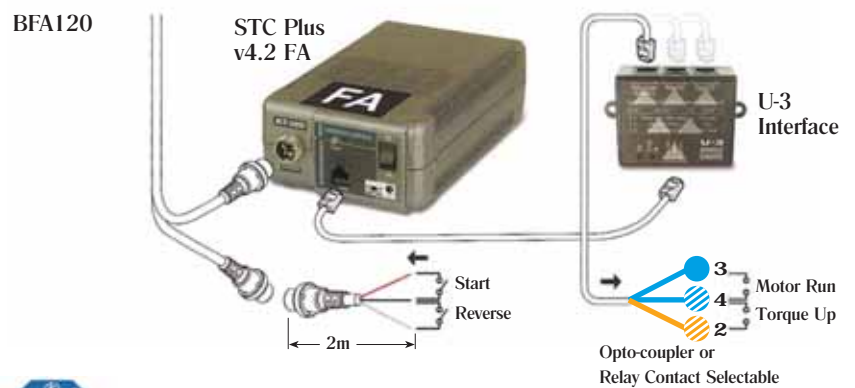

E-DRIV® KA & BFA-Series

Electric Torque Screwdrivers Robotic Style

KEY FEATURES

Models that range from 0.5 to 39 lbf.in.

Robotic style electric screwdriver for automated and fixtured applications.

Drivers include a front mounting flange.

Ensures accuracy in fastening with precision automatic shut-off clutch once preset torque is achieved.

External torque adjustment scale.

Forwarded and reverse direction by switch. Start & stop output signals.

Requires a Transformer (power supply).
STC30 Plus v4.1 FA (for only KA models)
Item # 145720

STC30 Plus v4.2 FA (for only BFA models)
Item # 145736

Model	Driver Type	Item #	Torque Ranges		RPM		Grip Dia.	Length	Drive Size	Weight
			lbf.in	cN.m	High	Low				
KA250-A	Direct Start	145715	1.8 - 21.7	19 - 245	1050	630	1 1/2"	10 1/4"	1/4" F/Hex	21.2 oz
KA350-A	Direct Start	145716	1.8 - 30.3	19 - 343	750	460	1 1/2"	10 1/4"	1/4" F/Hex	21.2 oz
KA450-A	Direct Start	145717	2.6 - 39	30 - 441	550	330	1 1/2"	10 1/4"	1/4" F/Hex	21.2 oz
BFA080 ESD*	Direct Start	145718	0.5 - 6.9	4.9 - 78.4	1000	670	1 1/4"	8 2/3"	1/4" F/Hex	15.2 oz
BFA120 ESD*	Direct Start	145719	0.5 - 10.4	4.9 - 117.6	700	460	1 1/4"	8 2/3"	1/4" F/Hex	15.2 oz

* Brushless & ESD style models.

SIGNAL CABLE

- 1 ● Orange
- 2 ▨ White with Orange Stripe
- 3 ● Blue
- 4 ▨ White with Blue Stripe
- 5 ● Green
- 6 ▨ White with Green Stripe
- 7 ● Brown
- 8 ▨ White with Brown Stripe

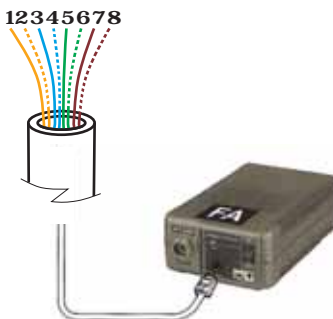

FLANGE DIMENSIONS mm

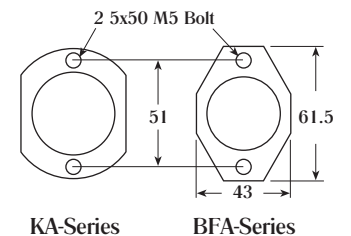

BL-Series

Electric Torque Screwdrivers Brushless



KEY FEATURES

Various models that range from 0.17 - 30 lbf.in.

High performance brushless motor design provides durability and reduces the standard maintenance cost for electric drivers.

Designed for high production environments. Minimal heat build-up even when tool is operated continuously.

Soft texture ergonomic grip.

Start Systems

BL-2000 models: Lever Start.

BL-3000, 5000 and 7000 models: Two-way Start System (switchable between Lever Start and Push-to-Start).

Vacuum and ESD models available.

ESD models prevent the occurrence of electrostatic discharge, which improves production yields, manufacturing costs, product quality, product reliability, reputation, and profitability.

Torque adjustment scale.

Requires a transformer (power supply).

NOTE!

For Torque Chart, see pages 02.2 & 02.3

*OPC models are designed to only operate with the HIOS BLOP-STC Screw Counter Transformer, see pages 02.17 & 02.18

Model	Driver Type	Item #	Torque Ranges		RPM		Grip Dia.	Length	Drive Size	Weight
			lbf.in	cN.m	High	Low				
BL-2000ESD	ESD Lever Start	144390	0.17 - 1.7	2 - 20	990	650	1"	6 3/4"	4mm HIOS	9 oz.
BL-2000ESD-OPC*	ESD Lever Start	144312	0.17 - 1.7	2 - 20	990	650	1"	6 3/4"	4mm HIOS	9 oz.
BL-3000	Lever & Push-to-Start	144393	1.7 - 4.8	2 - 55	980	680	1 1/4"	7 1/2"	4mm HIOS	11.3 oz.
BLQ-3000	Vacuum Lever Start & Push-to-Start	144394	1.7 - 4.8	2 - 55	980	680	1 1/4"	7 1/2"	4mm HIOS	11.6 oz.
BL-3000ESD	ESD Lever & Push-to-Start	144395	1.7 - 4.8	2 - 55	980	680	1 1/4"	7 1/2"	4mm HIOS	11.3 oz.
BLQ-3000ESD	Vacuum/ESD Lever & Push-to-Start	144396	1.7 - 4.8	2 - 55	980	680	1 1/4"	7 1/2"	4mm HIOS	11.6 oz.
BL-3000-OPC*	Lever & Push-to-Start	114313	1.7 - 4.8	2 - 55	980	680	1 1/4"	7 1/2"	4mm HIOS	11.3 oz.
BL-5000X	Lever & Push-to-Start	144383	1.7 - 10	20 - 120	900	590	1 1/4"	8"	1/4" Female/Hex	12.7 oz.
BLQ-5000X	Vacuum Lever & Push-to-Start	144388	1.7 - 10	20 - 120	900	590	1 1/4"	8"	1/4" Female/Hex	13 oz.
BL-5000XESD	ESD Lever & Push-to-Start	144385	1.7 - 10	20 - 120	900	590	1 1/4"	8"	1/4" Female/Hex	12.7 oz.
BLQ-5000XESD	Vacuum/ESD Lever & Push-to-Start	144387	1.7 - 10	20 - 120	900	590	1 1/4"	8"	1/4" Female/Hex	13 oz.
BL-5000X-OPC*	Lever & Push-to-Start	144389	1.7 - 10	20 - 120	900	590	1 1/4"	8"	1/4" Female/Hex	12 oz.
BL-7000X	Lever & Push-to-Start	144397	6.1 - 24	70 - 280	960	630	1 1/2"	8"	1/4" Female/Hex	22.6 oz.
BL-7000XESD	ESD Lever & Push-to-Start	144398	6.1 - 24	70 - 280	960	630	1 1/2"	9 1/2"	1/4" Female/Hex	22.6 oz.
BL-7000X-OPC*	Lever & Push-to-Start	144376	6.1 - 24	70 - 280	960	630	1 1/4"	9 1/2"	1/4" Female/Hex	22.6 oz.
BL-7000X-HT	Lever & Push-to-Start	144399	6.1 - 30	70 - 340	740	500	1 1/2"	9 1/2"	1/4" Female/Hex	22.6 oz.
BL-7000X-HTESD	ESD Lever & Push-to-Start	144309	6.1 - 30	70 - 340	740	500	1 1/4"	9 1/2"	1/4" Female/Hex	22.6 oz.



BITS

Power Bits

See Pages 04.2 & 04.3

HIOS Bits (shown)

See Page 04.6



HEX to HIOS ADAPTER

See Page 02.19



BALANCERS

Provides easy handling for operators that work with tools for long, continuous hours.

See Page 02.15



Balancers

These durable, compact balancers provide easy handling for operators that work with tools for long, continuous hours. The balancers allow tools to be positioned over the work station for comfortable operation and can be used with pneumatic, electric or hydraulic tools.



ZERO GRAVITY BALANCERS

Provides gravity defying - "true balance".

Compact & robust.

Easy external tensioning adjustment.

360° top swivel.

No tension build-up to cause worker fatigue.

Aircraft stranded steel cable.

Provision for safety cable.

Permanent lubrication (for MZ-6 through MZ-264 models).

Safety lock (for MZ-33 through MZ-264 models).

Model	Item #	Stroke		Weight Capacity		Weight lbs.
		in.	m.	lbs.	kg.	
MZ-3A	180500	19	0.5	1.1 - 3.3	0.5 - 1.5	0.5
A MZ-3B	180501	39	1	1.1 - 3.3	0.5 - 1.5	1.1
MZ-6	180502	51	1.3	2.2 - 6.6	1 - 3	3
MZ-11	180503	51	1.3	5.5 - 11	2.5 - 5	3.3
MZ-20	180504	51	1.3	10 - 20	4.5 - 9	7.5
B MZ-33	180505	51	1.3	19.8 - 33	9 - 15	8.4
MZ-48	180506	59	1.5	33 - 48.4	15 - 22	15.9
MZ-66	180507	59	1.5	48 - 66	22 - 30	16.8
MZ-88	180508	59	1.5	66 - 88	30 - 40	21.6
MZ-110	180509	59	1.5	88 - 110	40 - 50	23
MZ-132	180510	59	1.5	110 - 132	50 - 60	25.6
MZ-154	180511	59	1.5	132 - 154	60 - 70	26
MZ-198	180532	82	2.1	154 - 198	70 - 90	53
MZ-231	180533	82	2.1	187 - 231	85 - 105	57.3
MZ-264	180534	82	2.1	220 - 264	100 - 200	59.5

RETRACTOR BALANCERS

Lightweight & compact.

Easy to adjust tension by using handle.

Adjustable cable stop.

360° top swivel.

Provision for safety cable.

Model	Item #	Stroke		Weight Capacity		Weight lbs.
		in.	m.	lbs.	kg.	
C MJ-3	180521	59	1.5	1.1 - 3.3	0.5 - 1.5	0.7
MR-3	180515	79	2	1.1 - 3.3	0.5 - 1.5	1.1
D MR-6	180516	79	2	2.2 - 6.6	1 - 3	1.5
MR-11	180517	79	2	5.5 - 11	2.5 - 5	2

HOSE REEL BALANCERS

Designed for small pneumatic tools.

Integrating air hose & support cable keep work area clean.

Easy to adjust tension by using handle.

Provision for safety cable.

1/4" NPT Connector.

Model	Item #	Stroke		Weight Capacity		Weight lbs.
		in.	m.	lbs.	kg.	
E MH-3	180512	51	1.3	1.1 - 3.3	0.5 - 1.5	1.1
MH-6	180513	51	1.3	2.2 - 6.6	1 - 3	2.2
MH-11	180514	51	1.3	5.5 - 11	2.5 - 5	2.9

TOOL POSITIONER BALANCER

Lightweight & small.

Tool will remain at whatever level or position left in.

Model	Item #	Stroke		Weight Capacity		Weight lbs.
		in.	m.	lbs.	kg.	
F Mini 31	180029	60	1.5	1 - 12	0.4 - 5.6	.75

SureFeed

Table Top Screw Presenter with Changeable Rail Units

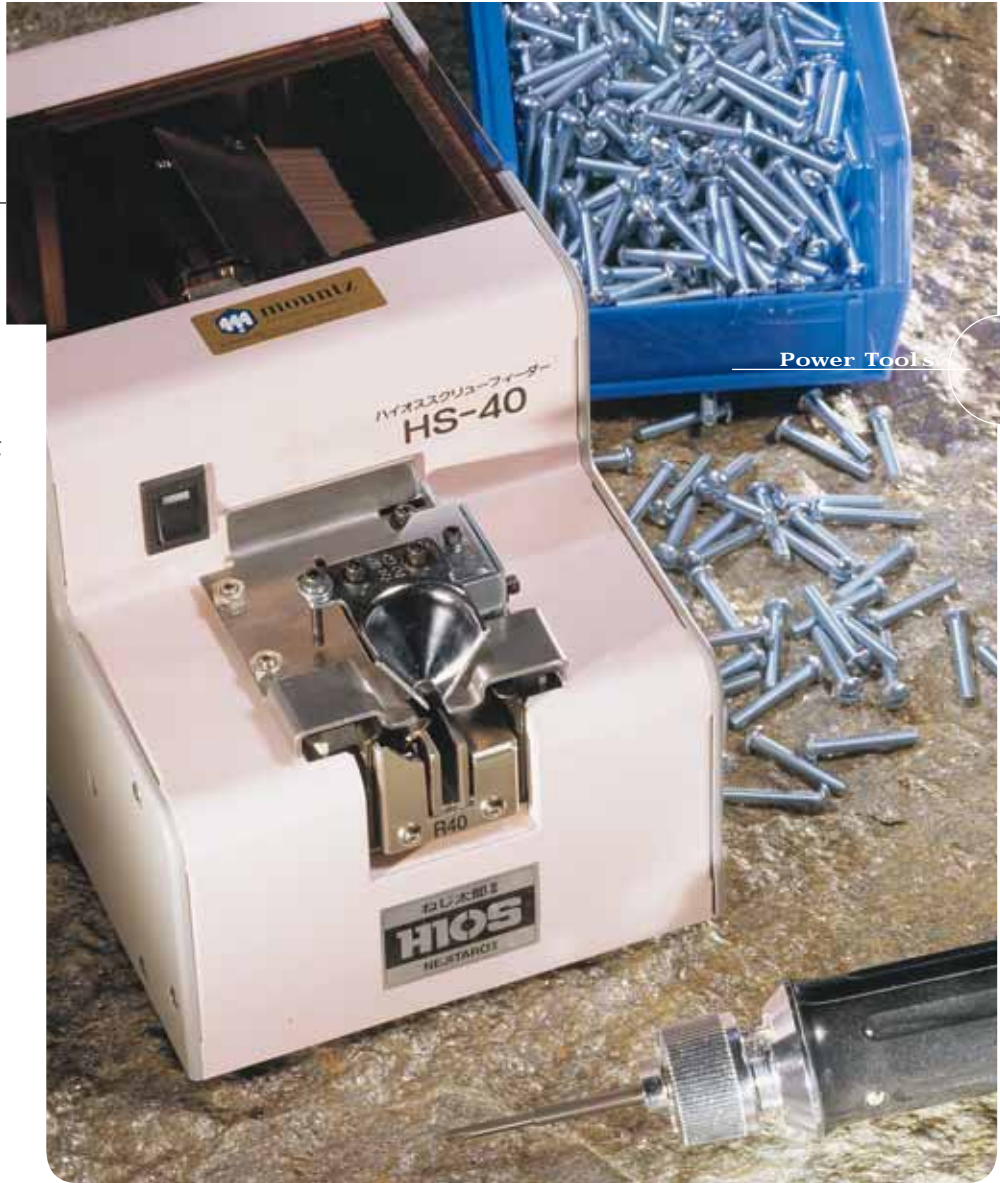

Power Tools

KEY FEATURES

The SureFeed is a high precision yet inexpensive table top screw-feeder designed to enhance productivity.

This simple mechanism allows trouble free operation, eliminating jammed or stuck screws.

Screws are poured into hopper and automatically lined up.

The unique up and down screw hopper feeds screws efficiently into the screw-feeding rail and the photosensors prevent screws from jamming or sticking.

Pick up rate of up to two screws per second.

The versatile unit can easily change to another screw by simply changing the screw-feeding rail. It can feed sems, w-sems, washer-head, and flat head screws.

HSF Models feature an ultra-slim and compact design (5mm or 2 1/8" wide) for efficient use of small workstations.

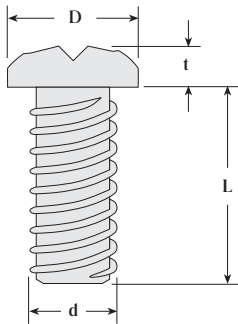

HS-SERIES

Model	Item #	Max. Head Diameter	Max. Shaft Diameter	Max. Head Height	Max. Length	Dimensions	
		D - mm	d - mm	t - mm	L - mm	W x D x H	Weight
HS-14C	144702	9.6 (0.377")	1.4 (0.055")	7.1 (0.279")	20 (0.7874")	4 7/8" x 7 1/8" x 5 3/4"	6.6 lbs.
HS-17C	144703	9.6 (0.377")	1.7 (0.066")	7.1 (0.279")	20 (0.7874")	4 7/8" x 7 1/8" x 5 3/4"	6.6 lbs.
HS-20	144705	10 (0.393")	2 (0.078")	7.1 (0.279")	18 (0.7086")	4 7/8" x 7 1/8" x 5 3/4"	6.6 lbs.
HS-23	144706	10 (0.393")	2.3 (0.090")	7.1 (0.279")	18 (0.7086")	4 7/8" x 7 1/8" x 5 3/4"	6.6 lbs.
HS-26	144707	10 (0.393")	2.6 (0.102")	7.1 (0.279")	18 (0.7086")	5 1/8" x 8 1/2" x 5 1/3"	7 lbs.
HS-30	144701	10 (0.393")	3 (0.118")	7.1 (0.279")	18 (0.7086")	5 1/8" x 8 1/2" x 5 1/3"	7 lbs.
HS-40	144708	13.4 (0.527")	4 (0.157")	8.4 (0.330")	18 (0.7086")	5 1/8" x 8 1/2" x 5 1/3"	7 lbs.
HS-50	144709	13.4 (0.527")	5 (0.196")	8.4 (0.330")	18 (0.7086")	5 1/8" x 8 1/2" x 5 1/3"	7 lbs.

Requires the use of a bit with a reduced shank due to the design of the "bit guide". Please contact customer service.

HSF-SERIES

Model	Item #	Max. Head Diameter	Max. Shaft Diameter	Max. Head Height	Max. Length	Dimensions	
		D - mm	d - mm	t - mm	L - mm	W x D x H	Weight
HSF-10	144723	2.2 (0.087")	1 (0.039")	7.1 (0.279")	16 (0.629")	2 1/8" x 8" x 5 5/8"	5.3 lbs.
HSF-12	144724	2.5 (0.099")	1.2 (0.047")	7.1 (0.279")	16 (0.629")	2 1/8" x 8" x 5 5/8"	5.3 lbs.
HSF-14	144725	2.8 (0.393")	1.4 (0.055")	7.1 (0.279")	16 (0.629")	2 1/8" x 8" x 5 5/8"	5.3 lbs.
HSF-17	144726	3.4 (0.133")	1.7 (0.066")	7.1 (0.279")	16 (0.629")	2 1/8" x 8" x 5 5/8"	5.3 lbs.
HSF-20	144727	4.2 (0.165")	2 (0.078")	7.1 (0.279")	16 (0.629")	2 1/8" x 8" x 5 5/8"	5.3 lbs.
HSF-26	144728	5 (0.197")	2.6 (0.102")	7.1 (0.279")	16 (0.629")	2 1/8" x 8" x 5 5/8"	5.3 lbs.
HSF-30	144729	5.8 (0.228")	3 (0.118")	7.1 (0.279")	16 (0.629")	2 1/8" x 8" x 5 5/8"	5.3 lbs.

CHANGEABLE RAIL UNITS

The versatile unit easily changes to another screw by changing the screw-feeding rail. The rail unit can only be interchanged with units of the same body style. When selecting a different Rail Unit for a Model, the Push Plate must be changed as well for the appropriate rail (for HS-Series only).

Model	Max. Shaft Diameter	Changeable Rail Unit #	Push Plate #	Body Style
HS-14C	1.4	144710	-	HS-127
HS-17C	1.7	144711	-	HS-127
HS-20	2	144713	144719	HS-230
HS-23	2.3	144714	144719	HS-230
HS-26	2.6	144715	144720	HS-230
HS-30	3.0	144716	144720	HS-230
HS-40	4.0	144717	144721	HS-450
HS-50	5.0	144718	144722	HS-450

Model	Max. Shaft Diameter	Changeable Rail Unit #	Body Style
HSF-10	1	144730	HSF-01
HSF-12	1.2	144731	HSF-01
HSF-14	1.4	144732	HSF-01
HSF-17	1.7	144733	HSF-01
HSF-20	2	144734	HSF-01
HSF-26	2.6	144735	HSF-02
HSF-30	3	144736	HSF-02

SUREFEED

02.16

HIOS

**Built-in
Controller**

**TRANSFORMER
WITH SCREW COUNTER**

Power supply with built-in screw counter. The quality control device provides visual assembly fastener count and audible reject alarm. Detects - cross threading, omissions, unfinished rundowns and cycle complete. (Visit website for more detail and images.)

Model: CLT-70STC3
Item #144296
Max. Output: 4.5A
Fuse: 3A
Break: -
Output VDC: 20 / 30
Input VAC: 100 - 240
Size (WxDxH):
4 3/4" x 7 1/2" x 2 3/4"
Weight (lbs.): 3.5

Model: BLOP-STC3
Item #144175
Max. Output: 4.5A
Fuse: 3A
Break: -
Output VDC: 20 / 30
Input VAC: 100 - 240
Size (WxDxH):
5" x 8 1/8" x 3"
Weight (lbs.): 4

**For Driver
Model s:**
CL2000 - 7000
A4500 - 6500
SS2000 - 7000

**For Driver
Model s:**
BL2000 OPC -
7000 OPC*

*Only operates with the "OPC" models from the BL-Series. Cannot operate with standard BL models.

Transformers

Power Supplies for DC Electric Screwdrivers



MC-70L

MC-70L TRANSFORMER

Operates between 2 - 20 tools, depending on type of drivers being used. Requires CB105 Sub Control Boxes. Selectable two speed (high and low). The maximum number of drivers that can be used with the MC-70L is based on the premise that all drivers will be in use simultaneously.

Model: MC-70L
Item #144164
Max. Output: 15A
Fuse: 5A
Break: 10A
Output VDC: 20 / 30
Input VAC: 120
Size (WxDxH): 12 1/2" x 8 2/3" x 6"
Weight (lbs.): 26.4



**(up to 5 drivers)
A6500**

**(up to 10 drivers)
A4500 - 5000
CL6000 - 7000
SS6500 - 7000**

**(up to 20 drivers)
CL2000 - 4000
SS2000 - 4000**

SUB CONTROL BOX

For use with MC-70L. Each control box has its own circuit board that diverts power from the motor to an electromagnetic brake when the driver reaches its preset torque.

Model: CB105
(includes a ground wire)
Item #144250
Cord Length: 78"
Size (WxDxH): 2 3/4" x 1 2/3" x 4"
Weight (oz.): 18.5

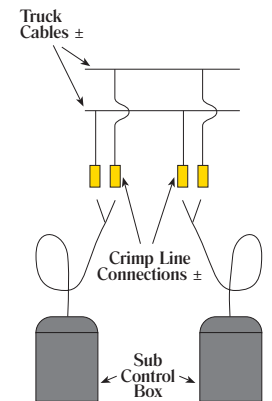

Diagram shows how the Sub Control Boxes interface with the truck cables to provide multiple driver use.

T-30BL

**Built-in
Controller**

**T-30BL
TRANSFORMER**

Switching power supply 100 - 240V. Selectable two speed (high & low).

Model: T-30BL
Item #144300
Max. Output: 1A
Fuse: 2A
Break: 4A
Output VDC: 31
Input VAC: 100 - 240
Size (WxDxH):
2 1/2" x 5 1/4" x 1 1/2"
Weight (lbs.): 0.7

**For Driver
Model s:**
BL2000 - 3000



T-70BL

**Built-in
Controller**

**T-70BL
TRANSFORMER**

Operates BL Series electric screwdrivers. Switching power supply 100 - 240V. Selectable two speed. Mountable brackets.

Model: T-70BL
Item #144400
Max. Output: 2A
Fuse: - 3.15A
Break: -
Output VDC: 31
Input VAC: 100 - 240
Size (WxDxH):
3 1/2" x 8 1/4" x 2"
Weight (lbs.): 1.8

**For Driver
Model s:**
BL2000 - 7000





STC30 TRANSFORMER

Selectable output voltage:
 - 20 / 30V for HIOS, BF, EF Series Drivers
 - 30 / 38V for K Series Drivers

Over Heat Protection (OHP) and Over Current Protection (OCP) protect driver from damage or malfunction.

Temperature Detection powers down the unit and resets automatically when unit restores to acceptable levels.

Switchable 110 & 230V input voltage. Unit will reset if motor/current is too high.

Start and Stop Signal Output (for PLC).

Selectable Soft Start (from 0.2 - 0.6 seconds).*

Selectable Double Hit mode for soft joint applications.*

Screwdriver lock Signal Input (for PLC).

Unit can be connected to the Scout (Screw Counter).

Model: STC30 Plus v4.1 (5-pin) **Item #145683**
 Operates: A-Series, CL-Series, EF-Series, K-Series & BF-Series

Model: STC30 Plus v4.1 (5-pin) **Item #145684**
 Operates: SS-Series & ESD-Series

Model: STC30 Plus v4.2 (6-pin) **Item #145699**
 Operates: BF-Series, Features Driver Lock

Rated Output: 2.5A
 Max. Output: 5A
 Fuse: 6.3A
 Break: -
 Output VDC: 20 / 30 or 30 / 38
 Input VAC: 110 / 230
 Size (WxDxH): 4 3/8" x 7 1/2" x 2 3/8"
 Weight (lbs.): 1.8

EF  **K***
Select EF Mode (20/30V) for operating the following Drivers:
 A4500 - 6500 CL2000 - 7000
 SS2000 - 7000 EF080 - 120

EF  **K***
Select K Mode (30/38V) Only operate K Series Drivers in this mode:
 K250 - 450
Note: For STC 30 Plus v4.1 Only



**U-3 INTERFACE CONVERTER
 STC 30 PLUS ACCESSORY**

The PLC interface converter provides three types of signals by converting the open collector signal from STC 30 Plus.

Model: U-3
Item #145619
 Size (WxDxH): 3" x 2 3/8" x 3/4"
 Types of Signals:
 Open Collector by Opto-Coupler (Reversed)
 Relay Contact (Normal Close)
 Relay Contact (Normal Open)



CLT-50 TRANSFORMER

Selectable two speed (high and low).

Model: CLT-50
Item #144276
 Max. Output: 2.5A
 Fuse: 2A
 Break: 4A
 Output VDC: 20 / 30
 Input VAC: 120
 Size (WxDxH):
 4 1/8" x 7 1/4" x 3 5/8"
 Weight (lbs.): 6

For Driver Models:
 CL2000 - 7000
 SS2000 - 7000
 A4500 - 6500*
 *CLT-50 may be used with A-6500 if torque is to be less than 10 lbf.in



CLT-65 TRANSFORMER

Selectable two speed (high and low).
 Ideal for A6500, SS7000, CL7000 under high torque applications.

Model: CLT-65
Item #144054
 Max. Output: 3.5A
 Fuse: 5A
 Break: 4A
 Output VDC: 20 / 30
 Input VAC: 120
 Size (WxDxH):
 7 1/8" x 5 1/2" x 5 1/4"
 Weight (lbs.): 8.8

For Driver Models:
 A4500 - 6500
 CL2000 - 7000
 SS2000 - 7000



CLT-75 TRANSFORMER

Model: CLT-75
Item #144177
 Max. Output: 8A
 Fuse: 5A
 Break: 8A
 Output VDC: 30
 Input VAC: 120
 Size (WxDxH):
 7 1/8" x 8 2/3" x 5 1/4"
 Weight (lbs.): 13.25

For Driver Model:
 CL9000



CLT-100 TRANSFORMER

Operates two drivers, either individually or simultaneously. The design of the circuit assures that the performance will not be affected by the operating the second driver.

Model: CLT-100
Item #144174
 Max. Output: 3.5A
 Fuse: 2A
 Break: 4A
 Output VDC: 20 / 30
 Input VAC: 120
 Size (WxDxH):
 7 1/8" x 5 3/4" x 5 1/8"
 Weight (lbs.): 8.8

For Driver Models:
 A4500 - 6500
 SS2000 - 7000
 CL2000 - 7000

Accessories

Electric Torque Screwdrivers



TOOL CRIB Item #064000

Prevents broken or dropped tools. Reduces tool bench clutter. Easy operator access.

Mounts in a variety of positions on the work bench or the production line. The flexible ToolCrib can rotate to 8 locations.

Hole at the bottom of ToolCrib allows for a bit to pass through.

Crafted with durable aluminum.



Surface Mount



Under Table Mount

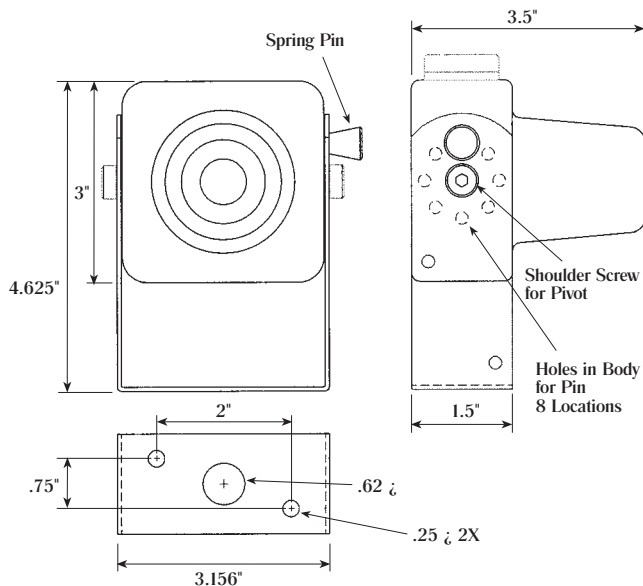

MAG-O-NETS

Magnetize bits by sliding a Mag-O-Net onto the bit.

(actual size)



Desc.	Item #	Inner Dia.	Outer Dia.	Package Quantity	Use
for 3/16" Shank Bit	145710	3/16"	17.5mm	10	For most 0 & 00 bits
for 5mm Shank Bit	145711	6mm	17.5mm	10	Reduced Dia. Bits
for 1/4" Shank Bit	145712	7mm	19mm	10	Standard Bits

Accessories

02.19



MOUNTZ RIGHT ANGLE ADAPTER

Designed with an industrial strength pneumatic driver head. Robust and durable. Easily mounts onto nose of driver. Only operational with Lever Start 1/4" F/Hex driver models. Size 4-1/8" x 1-1/2".

Item # | Fits Driver Models:

067061	K-Series
067062	A4500, A5000, CL4000, SS4000
067063	A6500, CL6000, CL6500, CL7000, SS6500, SS7000
067064	VZ-Series
067065	EF-Series
067067	Delvo 7100/7200 Series
067068	Delvo 7500 Series
067069	E-Series



HIOS RIGHT ANGLE ADAPTER

Only works with Lever Start 1/4" Female Hex drives. Keep torque output to within 70%. Threadstyle: 23.85 dia x 1.5mm pitch

Use with: A6500
CL6000, CL6500, CL7000
SS6500, SS7000

Size: 3" x 2-1/4"

Item # 144323



PUSH-TO-START ADAPTER

Converts lever operated tools to Push-to-Start models.

A4500, A5000, CL4000, SS4000

Item # 144342

CL3000, SS3000

Item # 144343

Hex to HIOS



DRIVE ADAPTERS

1/4" F/Hex Drive to 4mm HIOS Drive

Item # 144328

1/4" F/Hex Drive to 5mm HIOS Drive

Item # 144337

HIOS to Hex



4mm HIOS Drive to 1/4" F/Hex Drive

Item # 144327

5mm HIOS Drive to 1/4" F/Hex Drive

Item # 144332



MAGNETIZER / DEMAGNETIZER

Magnetize or demagnetize bits and parts instantly.

Item # 120815

PISTOL GRIPS

Converts inline drivers to pistol grip.



HIOS Models:
A6500
CL6000
CL6500
CL7000
SS6500
SS7000
Item #144341

K-Series Models:
K250
K350
K450

Standard
Pistol Grip
Attachment
(for K-Series)
Item #145713

ESD Pistol Grip Attachment
(for K-Series ESD Models)
Item #145714



EXTENSION CORD

Combine with existing power cord.
Works with A, BL, CL, EF, ESD,
K or SS Series Drivers.

Length: 10 ft.
Item #144180

Length: 16 ft.
Item #144181



COILED POWER CORD

Works with A, BL, CL, EF, ESD,
K or SS Series Drivers.

Length: 4 ft. coiled (5 ft. extended)
Item #41F9TR-8100



TOOL STAND

A rugged adjustable tool support stand. Prevent tool damage due to dropping or mishandling. Convenient tool positioning - adjust both vertically and horizontally. Electric tool cords can be tie-wrapped to the vertical base to keep work station clean. 360 degree swivel. Four foot high, maximum arm length 1.75 feet. A balancer is recommended.

Model: MT-10
Item #060050

Pneumatic Center Block

Fitted with a pre-tapped plumbing holes. For attaching air fittings or air hose on MT-10 Tool Stand.

Item #061385



BENCH CLAMP

Used to clamp MT-10 Tool Stand base to table tops. This handy unit eliminates hole drilling and secures the tool stand in place. It's flexible and ready to move at a moments notice.

Model: 311
Item #180035

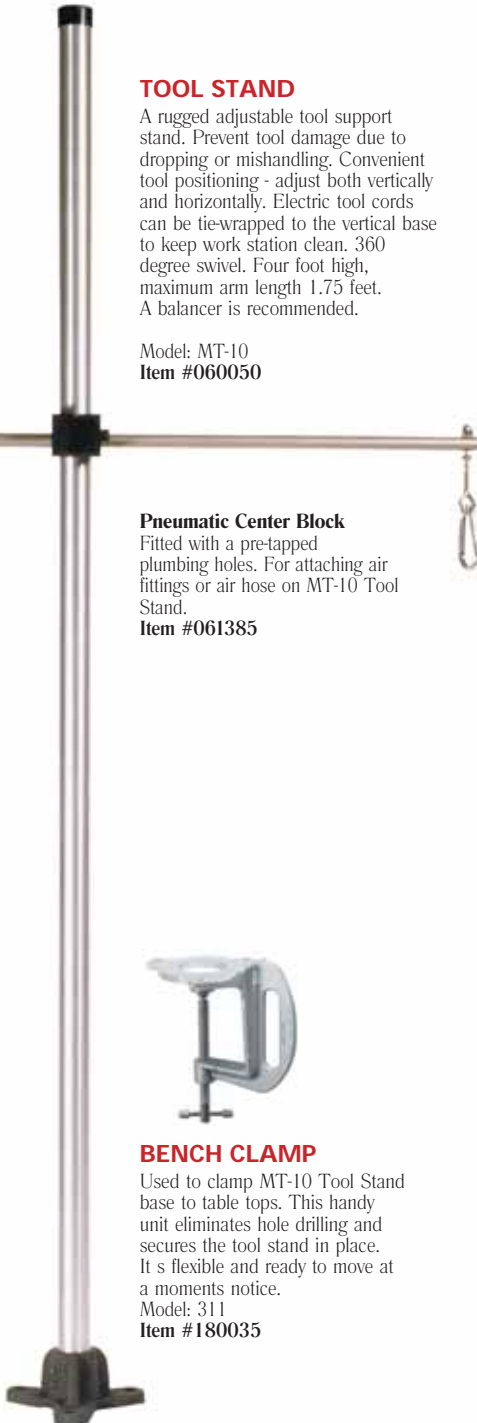

DRILL CHUCK

Converts all 1/4" drive tools for drilling applications. Chuck capacity 1/4". Comes with chuck key.

Item #144331

DRILL CHUCK KEY

Item #144336



TORQUE BUSTER

Designed to reduce operator injuries resulting from the torque transmitted from the power tool to the hand of the operator. High user comfort, decreases injuries, works in all orientations, and fits most power tools
Item #144315



e torque.com

Vacuum Accessories

Electric Torque Screwdrivers



SHAKER BOX Item #144301

For electric screwdriver equipped with vacuum adapter.

Manually shake to orientate screw heads up for fast pick-up with a vacuum system.

A variety of interchangeable grid plates snap in place to fit different size fasteners.

Both the shaker box and the grid plates are made of hard rubber to increase durability.

GRID PLATES

Item #	Slot Width		Fastener Size
	American	Metric	
144298	.047/.055	1.2/1.4	00
144303	.067	1.7	0
144304	.078	2.0	1
144299	.090	2.3	2
144305	.102	2.6	3
144306	.118	3.0	4
144307	.157	4.0	6

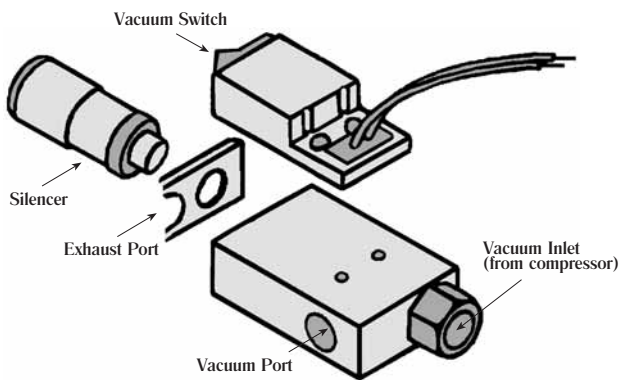

EJECT-TORR, VACUUM EJECTOR

This complete kit converts present shop lines into a vacuum system for fasteners.

The EJECT-TORR is small, light and easier to mount than conventional vacuum pumps.

No vacuum tanks and complicated piping are required.

The EJECT-TORR is vibration-free and produces comparatively little noise.

Model: ET-10HR
 Nozzle Dia: .038"
 Vacuum Flow (SCFM)(0"Hg): 0.88
 Achieved Vacuum: 26.7
 Air Compression (SCFM): 1.60
 Weight: 3 oz.
Item #144314



VACUUM ADAPTER KIT

Mounts easily to BF, BL, CL, EF, SS, A, ESD, and VZ-Series Drivers.

Accepts different size screws and various length fasteners.

Allows quick change set-up at a low cost.

Mounts with threaded torque nut. The driver remains externally adjustable while allowing semi-automatic pickup of non-ferrous fasteners.

Plug driver into vacuum supply or choose the Vacuum Ejector.

Mouthpiece and bit purchased separately.

Item # | Fits Driver Models:

144318	CL2000, SS2000*
144319	A4500, A5000, CL3000, CL4000, SS3000, SS4000*
144322	A6500, CL6000, CL6500, CL7000, SS6500, SS7000*
144345	BL3000*
144346	BL7000*
144356	VZ1820, VZ3012, VZ4506
144338	BL5000*
145612	BF080, BF120, EF080, EF120
061012	K250, K350, K450

*ESD models available on request.

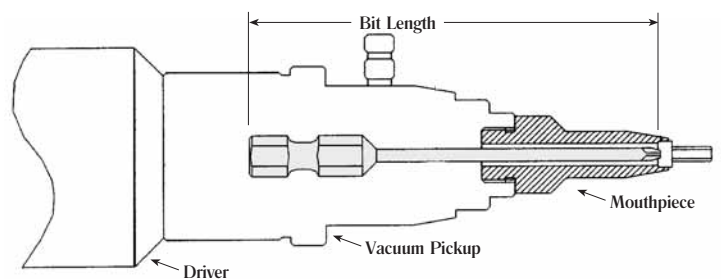
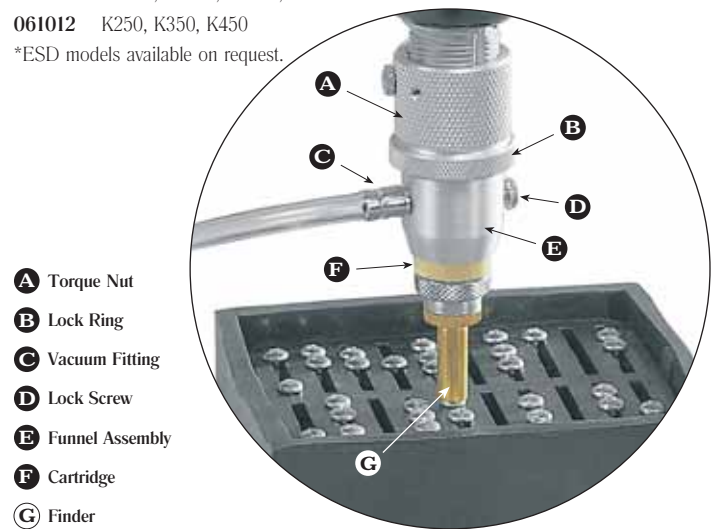

MOUTHPIECES

(Sold Separately from Kit above)

Standard mouthpieces are manufactured of stainless steel, unless specified. Modification Requirements listed are required for Mountz to design a mouthpiece to fit your specific application.

Modification Requirements

- Electric driver model.
- Torque setting.
- Drive size.
- Bit style and length.
- Fastener samples need to be submitted.
- Any special requirements, i.e. space restrictions.



Scout

Screw Counter

KEY FEATURES

- Prevents screw fastening errors.
- Detects - cross threading, omissions, unfinished rundowns and cycle complete.
- Detection of fastening error and buzzer alert. Displays error condition.
- Fastener accept and reject lights (Go / No Go).
- Visual assembly fastener count (count up or down), including total count.
- Measure and program fastening time.
- Ability to store multiple fastener settings with the Parameter mode.
- Adjustable parameter settings for the buzzer.
- Password protection and wall mountable.
- The Scout is powered by the STC30 Plus. It only operates with this transformer and works with most Mountz electric screwdrivers.

Outputs for machine and PLC interface for line control:

Input Features

- Cycle Start
- Driver Lock (prevents driver activation until PLC input signal)

Output Features

- OK
- NG
- Buzzer Alarm
- Cycle End

SCOUT SCREW COUNTER

Item #145614

(W x L x H): 4 1/2" x 5" x 1"
Weight: 0.75 lbs.

LEGEND

- A** Signal "In/Out" port for PLC
- B** Numeric LED (for the # of fastening screws)
- Fastening Result (OK or No Good)
- D** Enter, Left, Right & Menu Keys
- E** Port for connecting to transformer
- F** Menu LCD



ELECTRIC SCREWDRIVERS

Operates with:
 BF-Series, See Page 02.4
 EF-Series, See Page 02.6
 K-Series, See Page 02.6
 CL-Series, See Page 02.10
 A-Series, See Page 02.9
 SS-Series, See Page 02.7
 ESD Series, See Page 02.8

Connect With A:



STC30 PLUS TRANSFORMER

The Scout is powered by the STC30 Plus. It only operates with this transformer and works with most Mountz electric screwdrivers.
See Page 02.18



PLC INTERFACE BOX

Item #074996
 The PLC interface box (mountable) makes it easy to connect the Scout to a PLC system.
 (W x L x H): 3 1/4" x 5 1/2" x 1 1/2"
 Weight: 0.4 lbs.

etorque.com

ISO 9001 and ISO 17025 Company

Scout
02.22



KEY FEATURES

- Virtually shock-free operation.
- Low noise, vibration and maintenance.
- Built-in optical encoder.
- Custom software.
- Programmable digital torque settings.
- Current controlled Servo motor.
- Automatic recognition.
- Preset data memory (available in FED only).
- Reliable regardless of joint characteristic.
- Suitable for clean room uses (Class 100).

PED AND FED CONTROLLERS

They are comprised of a 32 bit risc-processor. Both controllers adopt the same fastening process control technology. An optical encoder inside each screwdriver monitors the rotation of the driver motor from the initial rotation until the completion of the fastening cycle. The torque coefficient or factors which influence the torque, is calculated by the controllers software from the continuously monitored electric current to the screwdriver motor and the time factor. The electric current from the controller to the screwdriver motor is based on that continuous analysis, controlled instant by instant. The screwdrivers torque output is in proportion to the controllers electric current output to the screwdrivers motor. The screwdrivers torque curve takes 0.1 seconds and is calculated by a functional circuit until it reaches the target torque. Once the target torque has been reached, it holds that torque for 0.2 seconds to stabilize the torque output.



- PED controller has 1 channel for setting the torque output as a standard (2 channel available).
- FED controller installed on a robot can catch and loosen an already seated (fastened) screw, and has memory for 8 preset fastening torque settings and 8 preset angle settings.
- BOTH controllers can be used for manual and automatic applications.

PED & FED

Generation III - Torque Control System

CUSTOM OPTIONS AND SETTINGS

User friendly Windows 95/98/NT® based software is available to customize the functions and parameters of the PEDIII and FEDIII controller.

Custom Functions

- LED (for M and S drivers).
- Screw binding release.
- Trigger switch and Forward/Reverse switch (for M and S drivers).
- Dual Torque: Manual or Auto Change-Over (for PEDIII).
- Slow start for initial engagement to minimize shock and cross threading of fasteners.

User Parameter Settings

- Changeable unit of measure (kgf.cm, N.m, lbf.in).
- Driver LED.
- Standard speed fastening.
- High speed fastening.
- Holding time of Peak torque (0 - 200ms).
- Screw binding release function parameters.
- Reversing parameters (FEDIII only).
- Idle mode parameters (FEDIII only).
- ATC (Auto Torque Compensation) fine-tuning to adjust the mechanical characteristics of the driver.

Multi-Sequence Operation

A programmable multi-sequence operation without a PLC (FEDIII) is available with the customized software.

FASTENING TORQUE RANGE AND RPM

The Driver Specifications below show the torque range for the drivers. The RPM is automatically selected in accordance with the torque value you program into the controller.

Each model has the ability to switch to either standard or high speed using the customized software.

If you require any specific RPM for certain fastening torque, please feel free to contact a customer service representative. We need to know your specific fastening torque in use, so we can determine if the RPM you require can be achieved.

Driver#	Torque Ranges (kgf.cm)			RPM	
	Output	Setting	Minimum	Standard Speed	High Speed
1200	0.3 - 1.2	0.24 - 1.35	0.01	350 - 1300	-
2200	0.5 - 2.2	0.5 - 2.4	0.02	130 - 750	-
3600	1.0 - 3.6	0.8 - 4.0	0.02	160 - 540	270 - 780
8500	2.0 - 8.5	1.6 - 10.0	0.1	60 - 320	100 - 650
12K	3.0 - 12	2.7 - 13.0	0.1	40 - 160	150 - 500
15K	4.0 - 15	3.5 - 16.5	0.1	30 - 100	150 - 450
20K	5.0 - 20	4.5 - 22.0	0.1	25 - 110	60 - 250
30K**	7.0 - 30	7.0 - 30	0.1	25 - 110	40 - 160

**Not offered in M-Series
Models are available with torque range in lbf.in

DRIVER SERIES

M-SERIES with automatic recognition

Forward/reverse operation with lever type on/off switch that activates the motor. Connects to FEDIII or PEDIII controllers. Used in hand operated applications. Equipped with a 1/4" female hex or 4mm diameter, D-Cut drive. FD & FH models (see chart below) come with a bit cushion mechanism, which has a moveable range of 10mm on the axis direction. The driver keeps the same bit pressure anywhere within the moveable range.

S-SERIES with automatic recognition

Forward/reverse operation with lever type on/off switch that activates the motor. Connects to FEDIII or PEDIII controllers. Used in hand operated applications. Equipped with a 4mm diameter, D-Cut drive. FD models (see chart below) come with a bit cushion mechanism, which has a moveable range of 10mm on the axis direction. The driver keeps the same bit pressure anywhere within the moveable range.

A-SERIES DRIVER with automatic recognition

The driver power and direction is controlled by either the FEDIII or PEDIII controllers, and are used for automatic applications. Equipped with a 1/4" female hex or 4mm diameter, D-Cut drive. FD & FH models (see chart below) come with a bit cushion mechanism, which has a moveable range of 10mm on the axis direction and ±1mm (from bit center) in the circumference direction (360°). The driver keeps the same bit pressure anywhere within the moveable range.

Driver Series					
M	S	A	Description	Drive Size	Driver #
SD	-	-	w/o Bit Cushion	4mm Dia, D-Cut	1200, 3600, 8500, 12K
FD	-	-	with Bit Cushion	4mm Dia, D-Cut	1200, 3600, 8500, 12K
SH	-	-	w/o Bit Cushion	1/4" F/Hex	8500, 12K, 15K, 20K
FH	-	-	with Bit Cushion	1/4" F/Hex	8500, 12K, 15K, 20K
-	SD	SD	w/o Bit Cushion	4mm Dia, D-Cut	1200, 2200, 3600, 8500, 12K
-	FD	FD	with Bit Cushion	4mm Dia, D-Cut	1200, 2200, 3600, 8500, 12K
-	-	SH	w/o Bit Cushion	1/4" F/Hex	8500, 12K, 15K, 20K, 30K
-	-	FH	with Bit Cushion	1/4" F/Hex	8500, 12K, 15K, 20K, 30K

SYSTEM CONFIGURATION

The product line-up offers several choices to meet your requirements. The following will explain how to specify a system:

System (a controller + driver series/driver# + configuration)

Example: ● - ▲ ■ - ● (PEDIII - M8500 - SH)

● Controller Models: PEDIII and FEDIII

▲ Driver Series: M, S and A

■ Driver#: 1200, 2200, 3600, 8500, 12K, 15K, 20K and 30K

● Configuration: SD, FD, SH, and FH

BIT SLEEVE & GUIDE

A bit sleeve is unique to the application. In order to complete the order for your system, we require:

- sample of fastener or dimensions of fastener
- specific driver style being used
- shank diameter
- special requirements, i.e. space restrictions

EZ-Glider

Linear Torque Arms

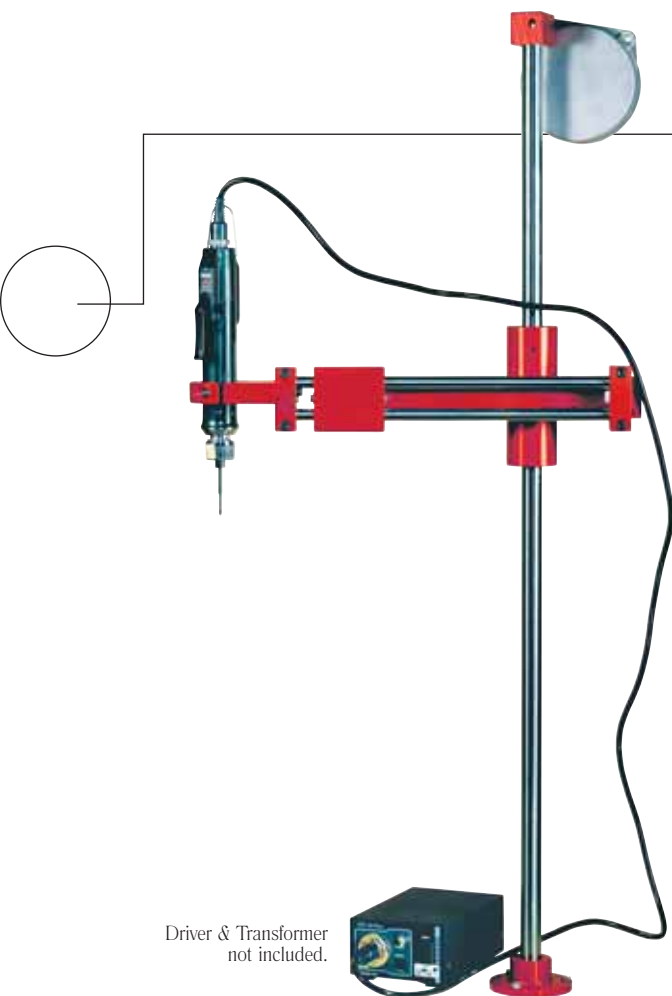

Driver & Transformer not included.

KEY FEATURES

- Prevents cross threading and side load. Keeps tool perpendicular.
- Reduces RMI (Repetitive Motion Injury) and CTS (Carpal Tunnel Syndrome) while boosting production.
- Extends in horizontal direction and arm length is adjustable.
- Maneuvers smoothly as the arm absorbs torque reactions from electric & pneumatic tools.
- Built with seasoned craftsmanship, every torque arm cylinder has four rows of ball bearings for smooth movement.
- A magnet on the backside of the tool clamp holds driver firmly against arm.
- Includes an in-line driver clamp.

LINEAR TORQUE ARMS

Model	Item #	Max Torque		Clamp Dia.	Height	Min Arm Reach	Max Arm Reach	Balancer Capacity
		American	S.I.					
EZ-12	260077	8.8 lbf.ft	12 N.m	1-1 1/2"	32 1/2"	16 1/2"	22"	1.1 - 2.6 lbs.
EZ-25	260078	18.4 lbf.ft	25 N.m	1-2"	36 1/2"	16 1/3"	22"	2.2 - 4.8 lbs.
EZ-40	260079	29.5 lbf.ft	40 N.m	1-2"	40 1/2"	21 7/8"	29 1/2"	3.1 - 4.8 lbs.
EZ-100	260080	73.7 lbf.ft	100 N.m	1-2"	40 1/2"	25 1/3"	33"	4.4 - 7.7 lbs.



NOTE!

An additional balancer (**Item #260152**) can be added to the EZ-40 & EZ-100 model to increase balancer capacity. The additional balancer increases the dual balancer capacity to 5.3 - 8.8 for the EZ-40, and 6.6 - 13.2 for the EZ-100.

ACCESSORIES



Servo-Assisted System

DOWNWARD ASSISTANCE KIT

These kits are ideal for self-tapping applications. The downward assistance system requires no effort from the operator to press downward on the driver as the operator simply presses the trigger of the driver and the cylinder glides the tool downward automatically. There are two system options available "Easy Push" and "Servo-Assisted".

Servo-Assisted system features a built in collet chuck that allows the system to be used at any height.

Easy Push system operates only at a preset height by using a mechanical stop that is set along the pole.

Both systems can be installed on a Linear or Articulated arm.

Model	Description	Item #	Pushing Force	Stroke
EZ-12	Servo-Assisted Electric Kit	260098	11 lbs.	-
EZ-25	Servo-Assisted Electric Kit	260099	17.6 lbs.	-
EZ-40/100	Servo-Assisted Electric Kit	260100	17.6 lbs.	-
EZ-12	Easy Push Electric Kit	260043	11 lbs.	4 7/8"
EZ-25	Easy Push Electric Kit	260041	19.8 lbs.	6 1/4"
EZ-40/100	Easy Push Electric Kit	260040	19.8 lbs.	7 7/8"
EZ-40/100	Easy Push Electric Kit	260039	33 lbs.	7 7/8"
EZ-100	Easy Push Electric Kit	260038	55 lbs.	7 7/8"

EXTENSION SLIDES

Expands the maximum arm reach of the EZ-Glider Linear Arms.

Model	Extends Max.	
	Arm Reach	Item #
EZ-12	27.5"	260088
EZ-25	27.5"	260089
EZ-40	36"	260090
EZ-100	41"	260091



EXTENSION DOUBLE SLIDE

Expands the maximum arm reach of the EZ-Glider Linear Arms by adding a second slide to the arm.

Model	Extends Max.	
	Arm Reach	Item #
EZ-12	31.5"	260092
EZ-25	30.5"	260093
EZ-40	41"	260094
EZ-100	46"	260095

ARP SYSTEM (not pictured)

ARP (automatic rest position): A recoil spring positioned on the slide to permit the arm to come back to the rest position as soon as you release it.

Model	Item #
EZ-12	260096
EZ-25	260097
EZ-40	260097
EZ-100	-



ANTI-ROTATING CLAMP

Attach an "Anti-Rotating" Clamp to prevent the arm from rotating side-to-side to help the operator target the screw quickly and precisely.

for EZ-12 & 25 Linear Arms
Item #260019

for EZ-40 & 100 Linear Arms
Item #260022

EZ-Glider

Articulated Torque Arms

KEY FEATURES

Prevents cross threading and side load. Keeps tool perpendicular.

Reduces RMI (Repetitive Motion Injury) and CTS (Carpal Tunnel Syndrome) while boosting production.

With the ability to bend like an elbow, the torque arm provides agility to position the tool in a variety of positions for different applications. Arm can be set at an inclination of 0°, 22.5° & 45°.

Provides smooth flexible range as the arm absorbs torque reactions from electric & pneumatic screwdrivers, angle nut runners, pulse tools, pistol grip style tools, grinders & drills.

Arm length is adjustable.

Includes an in-line driver clamp.

Versatile torque arm works with a variety of tools, using different tool clamp options: angle drivers, pistol grip drivers & in-line drivers.

Driver & Transformer not included.

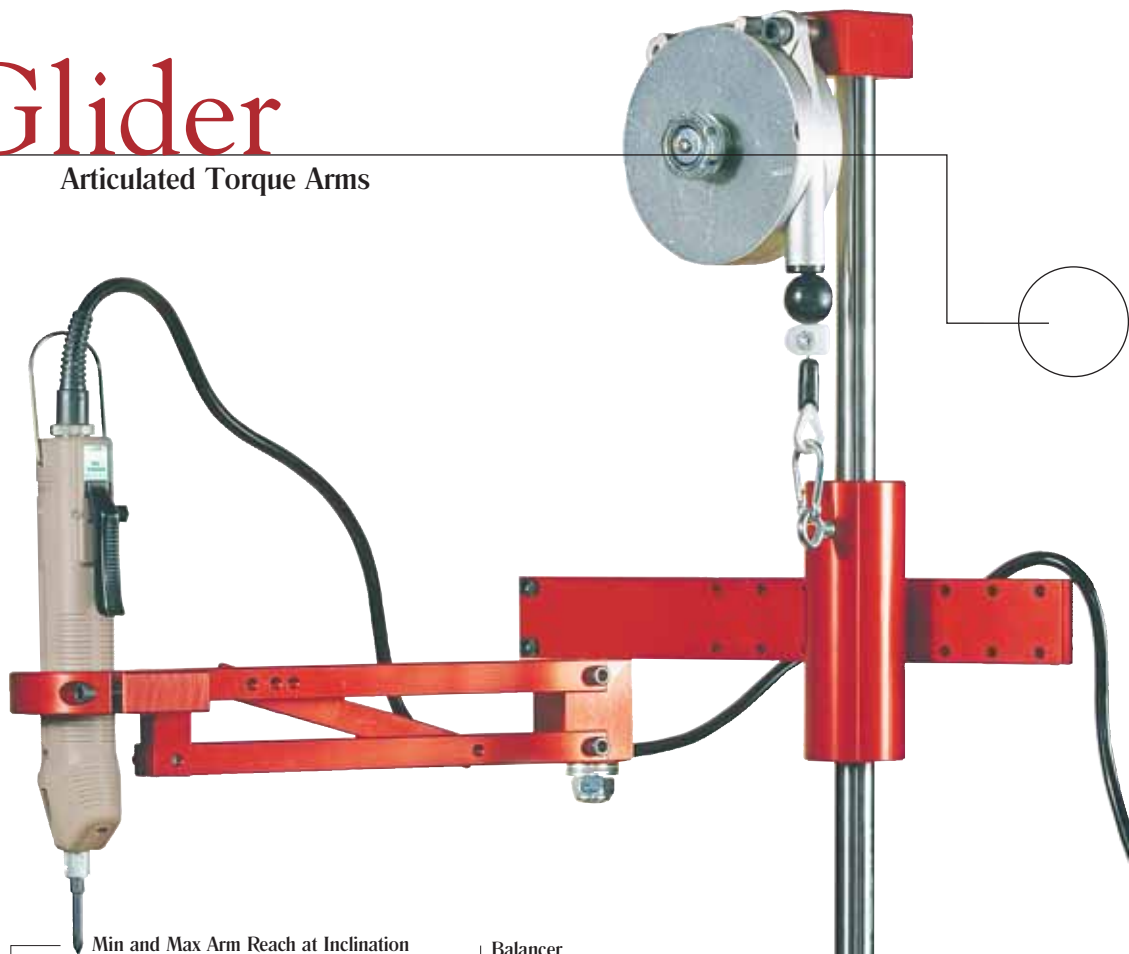

ARTICULATED TORQUE ARMS

Model	Item #	Max Torque		Height	Min and Max Arm Reach at Inclination			Balancer Capacity
		American	S.I.		0°	22.5°	45°	
EZ-12R	260081	8.8 lbf.ft	12 N.m	32 1/2"	15 1/8" - 21"	14 1/2" - 20"	12 1/3" - 18"	1.1 - 2.6 lbs.
EZ-25R	260082	18.4 lbf.ft	25 N.m	36 1/2"	15 1/2" - 21 1/2"	15" - 20 1/2"	12 7/8" - 18 1/2"	2.2 - 4.8 lbs.
EZ-40R	260083	29.5 lbf.ft	40 N.m	40 1/2"	22 1/4" - 30"	21 1/8" - 29"	18 1/8" - 26"	3.1 - 4.8 lbs.
EZ-100R	260084	73.7 lbf.ft	100 N.m	40 1/2"	26 1/3" - 34"	25 1/8" - 33"	22" - 29 1/2"	4.4 - 7.7 lbs.

NOTE!

An additional balancer (**Item #260152**) can be added to the EZ-40R & EZ-100R model to increase balancer capacity. The additional balancer increases the dual balancer capacity to 5.3 - 8.8 for the EZ-40R, and 6.6 - 13.2 for the EZ-100R.

ACCESSORIES

An in-line driver clamp is included with the torque arm. Other clamp options are available and sold separately.



Rotating Clamp



Pistol Grip Clamp



Angle Driver Clamp

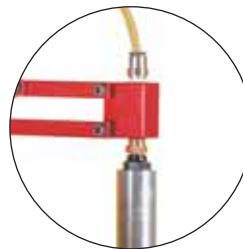

Nipple Clamp

Description	For Model: EZ-12R		For Models: EZ-25R & 40R		For Model: EZ-100R	
	Clamp Dia.	Item #	Clamp Dia.	Item #	Clamp Dia.	Item #
Rotating Clamp	1" - 1.5"	260027	1" - 2"	260030	-	-
Pistol Grip Clamp	1" - 1.5"	260008	1" - 2"	260031	-	-
Angle Driver Clamp	1" - 1.5"	260028	1" - 2"	260032	1" - 2"	260061
Nipple Clamp	*	260007	-	-	-	-

* Nipple clamp includes 1/4" and 1/8" - hose exhaust 8mm.

TRANSFORMERS

A wide variety of transformers are available.

See Pages
02.17 & 02.18



EZ-Glider

Telescoping Torque Arms



Driver not included.

KEY FEATURES

- Crafted with lightweight durable carbon fiber the arm collapses like a telescope.
- Easy-to-use, requires little space and doesn't disrupt production flow.
- The effortless handling of the torque arm provides comfortable tool operation and increased production.
- Mountable and easy to install on a wall, workbench and a standard rail or trolley system.
- Maintenance free.
- Eliminates torque reaction of power tools. Can be used with a variety assembly tools like, electric & pneumatic screwdrivers, angle nutrunners, pulse tools, pistol style tools, grinders, impact wrenches, drills, sanders, and percussion tools.
- Long arm reach capability up to 8 ft.
- Perfect for MVI applications.
- Universal Adapter included with EZ-12T, 30T, 80T & 140T models.
- Torque capacity up to 147.5 lbf.ft (200 N.m).

MOUNTING TO THE "STANDARD GLIDING RAIL SYSTEM"

The Telescoping Torque Arms can be mounted to the Standard Gliding Rail System (sold separately) and can be used in a variety of positions. For a vertical position it is necessary to install one additional item, an interface bracket (sold separately).



Standard Gliding Rail System	Working Distance/Item #					
	450mm	650mm	850mm	1050mm	1350mm	1850mm
	#260103	#260104	#260105	#260106	#260107	#260108

SLEEVE KIT (ACCESSORY)

Item # 260150

Connect Standard Gliding Rail System together.

INTERFACE BRACKET

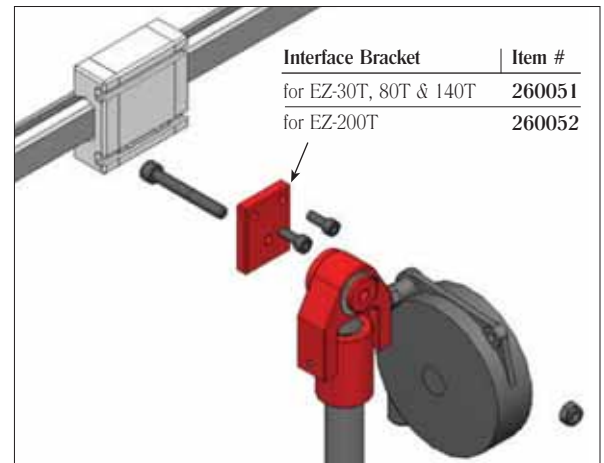

Interface Bracket	Item #
for EZ-30T, 80T & 140T	260051
for EZ-200T	260052

TOOL POSITIONING OPTIONS

Besides the standard in-line tool mounting position, the telescoping arm can be used with assembly tools in a variety of positions. For some tool positioning options, different tool clamp needs to be ordered separately.

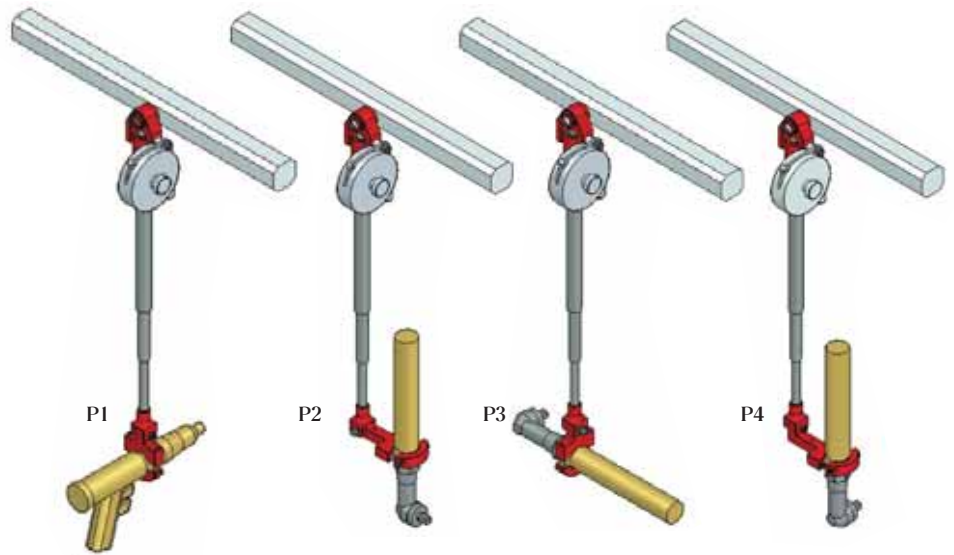
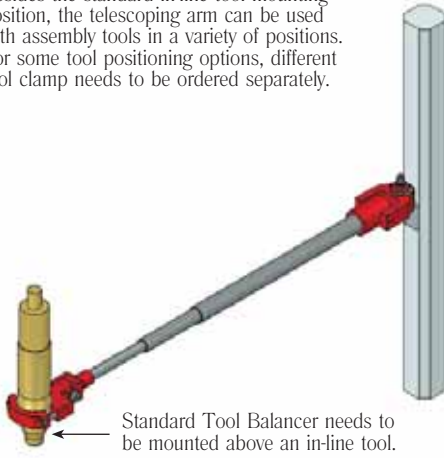

TELESCOPING TORQUE ARMS

Model	Item #	Max. Torque		Clamp Dia.	Min Arm Reach	Max Arm Reach	Weight of Arm	Tool Position Options			
		lbft.ft	N.m					P1	P2	P3	P4
EZ-12T	260075	8.8	12	1 - 1.5"	18.1"	37"	1.35 lbs.	Yes	No	No	No
EZ-12T/1500	260115	8.8	12	1 - 1.5"	25.6"	59"	2.7 lbs.	Yes	No	No	No
EZ-12T/2000	260116	8.8	12	1 - 1.5"	32.3"	78.7"	3.3 lbs.	Yes	No	No	No
EZ-30T	260076	22.1	30	1 - 2"	18.7"	37.5"	1.5 lbs.	Yes	Yes, Order Clamp #260145	Yes, Order Clamp #260144	Yes, Order Clamp #260146
EZ-30T/1500	260117	22.1	30	1 - 2"	25.8"	59"	3.3 lbs.	Yes	Yes, Order Clamp #260145	Yes, Order Clamp #260144	Yes, Order Clamp #260146
EZ-30T/2000	260118	22.1	30	1 - 2"	32.4"	78.7"	4 lbs.	Yes	Yes, Order Clamp #260145	Yes, Order Clamp #260144	Yes, Order Clamp #260146
EZ-30T/2500	260119	22.1	30	1 - 2"	39.1"	98.4"	4.4 lbs.	Yes	Yes, Order Clamp #260145	Yes, Order Clamp #260144	Yes, Order Clamp #260146

HIGH TORQUE TELESCOPING ARMS

Model	Item #	Max. Torque		Clamp Dia.	Min Arm Reach	Max Arm Reach	Weight of Arm	Tool Position Options			
		lbft.ft	N.m					P1	P2	P3	P4
EZ-80T/1500	260120	59	80	1 - 2"	28.1"	59"	6.6 lbs.	Yes	Yes	Yes	Yes, Order Clamp #260148
EZ-80T/2000	260121	59	80	1 - 2"	34.6"	78.7"	7.1 lbs.	Yes	Yes	Yes	Yes, Order Clamp #260148
EZ-80T/2500	260122	59	80	1 - 2"	41.3"	98.4"	7.7 lbs.	Yes	Yes	Yes	Yes, Order Clamp #260148
EZ-140T/1500	260123	103.3	140	1.25 - 2"	36.5"	59"	7.7 lbs.	Yes	Yes	Yes	Yes, Order Clamp #260148
EZ-140T/2000	260124	103.3	140	1.25 - 2"	46.4"	78.7"	8.4 lbs.	Yes	Yes	Yes	Yes, Order Clamp #260148
EZ-140T/2500	260125	103.3	140	1.25 - 2"	56.2"	98.4"	8.8 lbs.	Yes	Yes	Yes	Yes, Order Clamp #260148
EZ-200T/1500	260126	147.5	200	*	37.4"	59"	7.7 lbs.	Yes	Yes	Yes	Yes, Order Clamp #260149
EZ-200T/2000	260127	147.5	200	*	47.2"	78.7"	8.4 lbs.	Yes	Yes	Yes	Yes, Order Clamp #260149
EZ-200T/2500	260128	147.5	200	*	57.1"	98.4"	8.8 lbs.	Yes	Yes	Yes	Yes, Order Clamp #260149

* Customer must provide information (Brand & Model) on each tool being used with the arm. The clamp is custom made to fit the tool being used.

BALANCING KIT FOR VERTICAL MOUNTING

A balancing kit can be mounted on the side of any of telescoping arm. It allows the arm to be used with pistol grip tools and angle nutrunners (see tool position options above for using angle nutrunners with arms).

Model	Item #	Balancer Capacity	Stroke
E1	260140	2.2 - 4.4 lbs.	63"
E2	260141	2.2 - 5.5 lbs.	78.75"
E3	260142	4.4 - 8.8 lbs.	78.75"
E4	260143	8.8 - 13.2 lbs.	78.75"

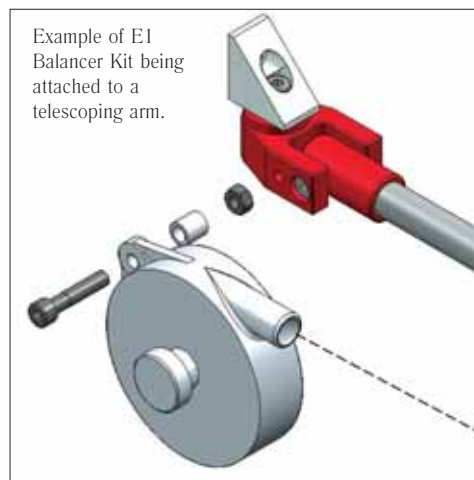

Example of E1 Balancer Kit being attached to a telescoping arm.



NOTE!

It is recommended to use a tool balancer with all EZ-Glider Telescoping Arm models. The telescoping arms should not be used at maximum arm reach on a permanent basis.

EZ-Slider

Sliding Torque Arms

KEY FEATURES

An ideal ergonomic solution for multi-tool applications such as a moving production and assembly line. Ideal for automotive production lines.

Maintenance Free.

Arm is crafted with a lightweight durable carbon fiber.

Easy to install and improves operator comfort and productivity.

Requires little space and doesn't disrupt production flow.

Mountable with a standard rail system, trolley, aluminum extrusion, wall or existing work station.

Eliminates torque reaction of power tools. Can be used with a variety of assembly tools like angle nutrunners and electric & pneumatic screwdrivers.

Arm slides up and down and provides X & Y axis mobility.

EZ-SLIDER TORQUE ARMS

Model	Item #	Max Torque		Clamp Dia.	Max Vertical Stroke	Balancer Capacity
		lbf.ft	N.m			
EZ-Slider 8	260101	5.9	8	*	17 3/4"	4.4 - 6.6 lbs.
EZ-Slider 15	260102	11	15	*	17 3/4"	4.4 - 6.6 lbs.
EZ-Slider 40	260129	29.5	40	1 - 2"	16 1/2"	13.2 - 17.6 lbs.
EZ-Slider 80	260130	59	80	1 - 2"	16 1/2"	17.6 - 22 lbs.

* The EZ-Slider 8 & 15 comes with a standard 3/8" air fitting. An electric tool clamp is sold separately.

ACCESSORIES

GLIDING RAIL SYSTEM

EZ-Slider arm slides up and down. "Gliding Rail System" allows the EZ-Slider arm to glide horizontally (side-to-side) on a production floor. Combine these two items and get the "Slide & Glide" movement. The Gliding Rail System can mount to a standard rail system, wall, aluminum extrusion or existing overhead system and is available in a variety of lengths. The EZ-Slider mounts on to the "Carriage". Each Gliding Rail System includes one Carriage.



Model	Working Distance/Item #					
	Standard Gliding Rail System (for EZ-Slider 8, 15 & 40)	450mm #260103	650mm #260104	850mm #260105	1050mm #260106	1350mm #260107
High Torque Gliding Rail System (for EZ-Slider 80)	420mm #260131	820mm #260132	1320mm #260133	1820mm #260134		



CARRIAGE (Only for Standard Gliding Rail System)

Additional Carriages can be purchased separately and added only to the Standard Gliding Rail System, which allows for multiple Slider Arms to be used freely on a rail system. A Thrust Stopper should be placed between each carriage.

Item #260109



BALANCER CARRIAGE

Features a hook for mounting a tool balancer. It can only be mounted to the Standard Gliding Rail System.

Item #260042



THRUST STOPPER

When having multiple carriages mounted to the Standard Gliding Rail System, it's recommended to place a Thrust Stopper between each carriage.

Item #260044



TOOL CLAMP FOR ELECTRIC DRIVERS

Model	Item #	Clamp Dia.
EZ-Slider 8	260110	1 - 2"
EZ-Slider 15	260111	1 - 2"

*Clamps for VZ & VB-Series models ONLY.

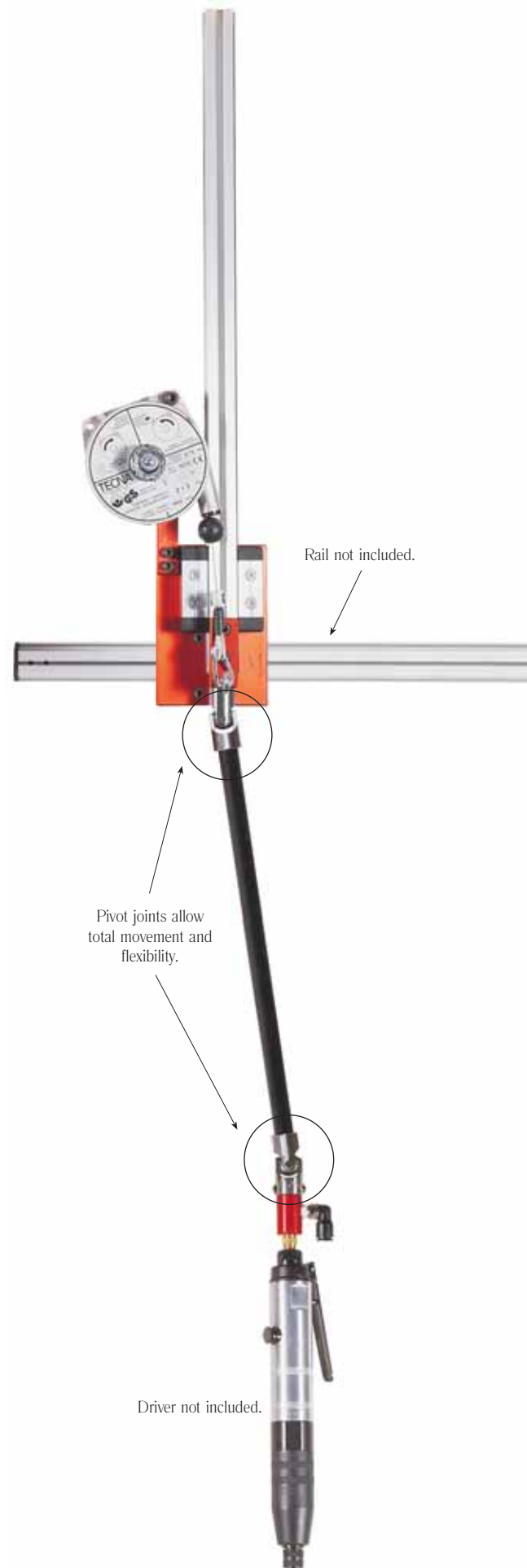

Section 03

Torque Wrenches

Mountz offers a variety of torque wrenches with different shapes, sizes and torque delivery mechanisms. Conventional wrenches click when torque is reached, dial wrenches accurately measure torque and cam and break-over style wrenches prevent overtightening. Most manufacturers make one style of wrench.

Instead of a one-size-fits-all philosophy, our selection ensures that the wrench you purchase will work properly for the job it was intended. Click Wrenches are undoubtedly the most widely used torque product in the world. Click wrenches typically emit a loud audible "click" when the set torque is reached. The click should also be felt in the handle to ensure recognition of torque delivery. Most click type wrenches break about 3 degrees after set torque is reached and then become positive. This positive action can cause over-torque conditions. Proper use and training is required so that operators stop pulling the moment the click sound is heard or felt.

Break-over type wrenches are essential to limiting the amount of torque applied to an assembly or fastening. Break-over torque wrenches, typically deflect 20-90 degrees on torque delivery, thus indicating torque has been reached. Many break-over wrenches require manual resetting, while others have an automatic resetting feature. Several styles of wrenches are available from Mountz. In this chapter you will find break-over wrenches for miniature inch ounce applications (**MMTB**), for connectors, fittings or general use (**TB & TBIH**) and for multi purpose applications (**MTBN**). Break-over wrenches are typically small in size and are able to fit in space constrained areas. Many interchangeable head fittings are available for flexibility and multiplicity of use.

Mountz dial wrenches (**ADS-EDS**) are robust and durable. Dial wrenches are typically used as a quality control instrument to verify or monitor torque. However, some customers find them a resourceful production tool. In all cases, Mountz dial wrenches are found to offer unmatched performance for several key reasons. First, they are simple and easy to calibrate. Second, they incorporate an overload protection device to prevent over-torque and damage to parts or to the wrench. Third, Mountz dial wrenches are non-length dependent, which means one can hold the wrench anywhere along the handle and exact torque will be achieved. Lastly, the wrench offers a double-ended ratchet that allows the torque to be measured in both directions.

Cam-over wrenches are perfect for maintenance and production applications where over-torque conditions are not tolerated. Each cam-over wrench utilizes a ball and lobe design allowing the wrench to slip free when torque is reached, eliminating the possibility of over-torque. Cam-over wrenches are non-length dependent and effectively take the guesswork out of torque delivery. Mountz offers **TSN, TSP & TSC** wrenches for a variety of standard and special applications. The use of cam-over wrenches takes operator influence out of the torque equation and offers more accurate and repeatable results than a standard click type wrench.

The majority of equipment sold by Mountz meets or exceeds the principal requirements of International Standard ISO 6789:2003. Official ISO specification can be obtained by contacting: (212) 642-4900.

These standards state:

- The effective working range of a tool is from 20% to 100% of its maximum torque value.
- The accuracy requirements for torque wrenches is as follows:
 - Tools < 10 N.m \pm 6% of setting
 - Tools > 10 N.m \pm 4% of setting
- The maximum torque value for each Square Drive size.
- An overload ability of 125% of maximum torque capacity.
- A calibration life of 5000 cycles.
- Test and measuring procedures, at 20° + 5° C.
- The accuracy of calibration devices to be + 1% of reading or better.
- Scale and marking requirements.

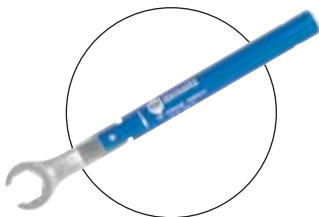

BREAK-OVER WRENCHES

Are essential for limiting the amount of torque applied to an assembly or fastening.

See MMTB Page 03.6
See TBIH Page 03.8
See TB Page 03.9
See MMTB Page 03.7



DIAL WRENCHES

Are robust and durable and are typically used as a quality control instrument to verify or monitor torque.

See Pages 03.20 & 03.21



CAM-OVER WRENCHES

Are perfect for maintenance and production applications where over-torque conditions are not tolerated.

See TSN Page 03.4
See TSC & TSP 03.3

Wrench Chart

Selecting the Proper Torque Wrench

There are a wide variety of "Preset" and "Adjustable" torque wrenches and selecting the shape and size for your application can be easy. However, understanding the variety of torque delivery mechanisms of torque wrenches can be confusing.

A "Preset" torque wrench is similar to a person setting an alarm clock to signal the achievement of a selected time. The wrench is preset to the required torque value of the application and then the tool signals the user when torque is achieved. A preset torque wrench must be preset using a torque analyzer. An "Adjustable" torque wrench features a torque scale that allows you to see and adjust the torque setting.

There are three styles in which the wrench can signal achieving torque, either by a "click," "break," or "slip". Each of three wrench styles have a specific purpose and utility. When you decide to spend the money for one, it's important that you select the one that will do the job properly and not generically.



CLICK WRENCHES

"Click" wrenches are the most widely used torque product in the world. When the set torque is reached, the tool typically emits a loud audible "click." The operator can feel the impulse from the tool and most break about 3° after set torque is reached and then become positive. This positive action can cause over-torque conditions. Proper use and training is required so that operators stop pulling the moment the click sound is heard or felt. Resetting of the tool takes place when the hand pressure is released. Work can then immediately continue on the next fastener.

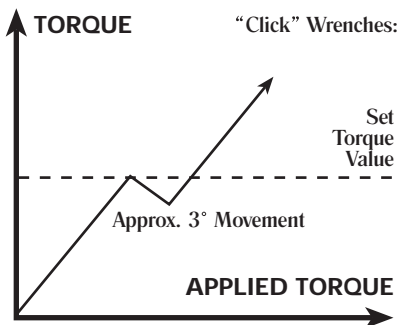

"Click" Wrenches:

Reset when pressure is released - length dependent.



BREAK-OVER WRENCHES

"Break-Over" wrenches are essential to limiting the amount of torque applied to an assembly or fastening. Upon reaching the preset torque value, the tool "breaks" at a specific point along the tool's length - usually at a pivot point near the tool's head. It typically deflects 20° or 90° on torque delivery; thus indicating torque has been reached. Continuing force after the break will increase the torque applied above the preset value. Many break-over wrenches require manual resetting, while others have an automatic resetting feature.

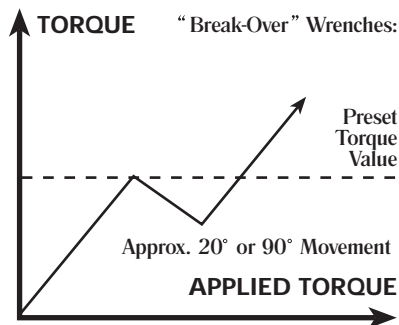

"Break-Over" Wrenches:

Reset in in-line position - length dependent.



CAM-OVER WRENCHES

"Cam-Over" wrenches utilize a ball and lobe design that allows the tool to slip free when torque is reached. Even if the application of force is repeated, the preset torque value won't be exceeded, eliminating the possibility of over-torque. These tools are perfect for maintenance and production applications where over-torque conditions are not tolerated. The use of cam-over wrenches takes the operator influence out of the torque equation and offers more accurate and repeatable results than a standard "click" type wrench.

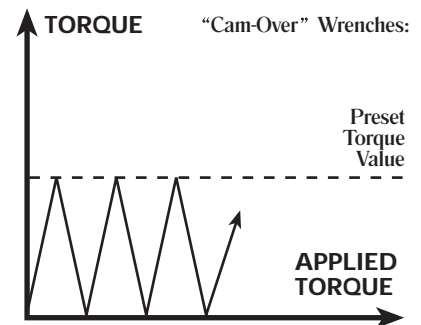

"Cam-Over" Wrenches:

Reset automatically - non-length dependent.



TSC & TSP

Cam-Over Torque Wrenches
Preset and Adjustable

KEY FEATURES

Designed and manufactured to meet or exceed the accuracy and repeatability requirements of ISO 6789:2003 ($\pm 6\%$ of setting).

When the preset torque is reached, the unique cam action provides high repeatability while eliminating overtorquing.

Anodized quality finish with stainless steel head.

Comfortable rubber hand grip.

Slim profile and light weight.

Non-length dependent.

ESD compliant (IEC 61340-5-1:1998).

TSP features a tamper-proof internal adjustment. No external adjustment scale – must be preset using a torque analyzer.

TSC features externally adjustable micrometer scale and easy-to-use positive locking adjustment system.

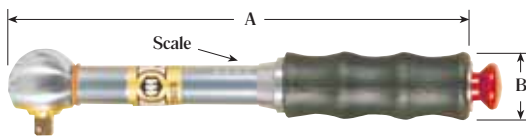

TSC - EXTERNALLY ADJUSTABLE

Model	Item #	Torque Ranges		Graduations
		lbf.in	N.m	
TSC5	020338	-	1 - 5	0.05 N.m
TSC10	020339	-	2 - 10	0.1 N.m
TSC45	020340	10 - 45	-	0.5 lbf.in
TSC90	020341	20 - 90	-	1.0 lbf.in

DIMENSIONS AND WEIGHT

Model	Length A		Diameter B		Square Drive	Weight	
	in.	mm	in.	mm		oz.	gm.
TSC5	7.68	195	1.14	29	1/4"	8.3	235
TSC10	7.68	195	1.14	29	1/4"	8.3	235
TSC45	7.68	195	1.14	29	1/4"	8.3	235
TSC90	7.68	195	1.14	29	1/4"	8.3	235



TSP - INTERNALLY ADJUSTABLE

Model	Item #	Torque Ranges		
		lbf.in	N.m	kgf.cm
TSP5/45	020342	10 - 45	1 - 5	10.2 - 51
TSP10/90	020344	20 - 90	2 - 10	20.4 - 102

DIMENSIONS AND WEIGHT

Model	Length A		Diameter B		Square Drive	Weight	
	in.	mm	in.	mm		oz.	gm.
TSP5/45	7.28	185	1.14	29	1/4"	6.7	190
TSP10/90	7.28	185	1.14	29	1/4"	6.7	190



SOCKETS

See Page 04.9



NOTE!

For Signal Output (Electric Signal) and TALS (RF Transceiver) models, see page 03.18

Left-Hand, Pin-Retention & CW Direction Only Models available upon request. (See website www.ettorque.com)



TSP - HANGING LOOP

Replace end cap of TSP with a "Loop" end cap for hanging the wrench safely when it is not being used. Sold separately.

Item #020587



Torque Wrenches

KEY FEATURES

Designed and manufactured to meet or exceed the accuracy and repeatability requirements of ISO 6789:2003 ($\pm 4\%$ of setting).

A preset production torque wrench.

The wrench "slips" free when preset torque is reached, thus eliminating overtorquing.

Tamper-proof internal adjustment. No external adjustment scale - must be preset using a torque analyzer.

Non-length dependent.

Fully supported non-strip ratchet head.

Strong corrosion-resistant stainless steel head, protective coated handle and non-slip rubber grip.

Features the new mechanical torque adjustment locking device (M-TALD). An auto locking single key operation prevents tampering.

ESD compliant (IEC 61340-5-1:1998).

TSN

Cam-Over Torque Wrench Internally Preset

Model	Item #	Torque Ranges		
		lbf.ft	N.m	kgf.m
TSN25D	020250	2 - 18	3 - 25	0.3 - 2.5
TSN25A	020249	2 - 18	3 - 25	0.3 - 2.5
TSN55	020251	10 - 40	15 - 55	1.5 - 5.6
TSN125	020252	30 - 90	40 - 125	4 - 12.7

inches **DIMENSIONS AND WEIGHT**

Model	Length		Square Drive	Weight	
	in.	mm		lbs.	kg.
TSN25D	8 1/2	216	1/4"	0.75	0.34
TSN25A	8 1/2	216	3/8"	0.75	0.34
TSN55	12 3/4	324	3/8"	1.75	0.80
TSN125	18 1/8	460	1/2"	3.0	1.36

NOTE!

For Signal Output (Electric Signal) and TALS (RF Transceiver) models, see pages 03.18

For Insulated TSN wrenches see page 03.13

For Left-hand, Pin-Retention & CW Direction Only Models available upon request. (See Website www.eturque.com)



TSN HEAD PROTECTION COVERS

This rubber cover fits the head and protects the work piece from accidental damage from the tool during use. Ideal for production areas, like automotive industry.

Model	Item #
TSN25	020183
TSN55	020184
TSN125	020185



HANGING LOOP

Replace end cap of TSN with a "Loop" end cap for hanging the wrench safely when it's not being used. Sold separately.

Model	Item #
TSN25D	020588
TSN25A	020588
TSN55	020590
TSN125	020589

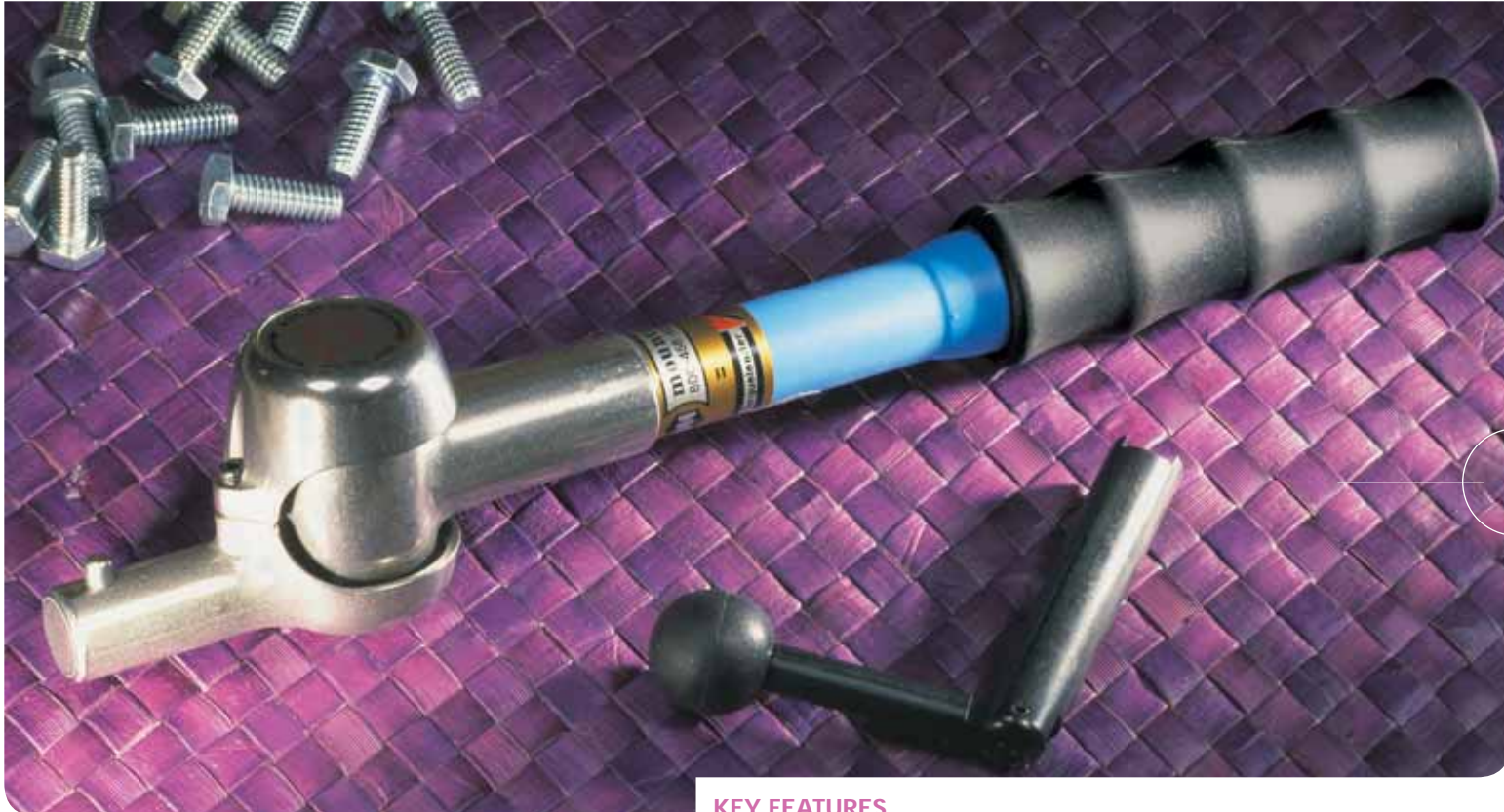

STB

Cam-Over Breaking Torque Wrench Internally Present



INTERCHANGEABLE HEADS

The versatile STB features a interchangeable end, which allows it to be used with a variety of head options.

1. Open End
2. Box End
3. Flare End
4. Ratchet Drive
5. Blank End

See Page 03.23



HANGING LOOP

Item #020588

Replace the end of the cap of the STB with a "Loop" end cap for hanging the wrench safely when it's not being used.

KEY FEATURES

Designed and manufactured to meet or exceed the accuracy and repeatability requirements of ISO 6789 2003 ($\pm 4\%$ of setting).

A preset production torque wrench.

The wrench "slips" through a 110° break before automatically resetting in-line reducing the possibility of overtorquing.

Tamper-proof internal adjustment. No external adjustment scale - must be preset using a torque analyzer.

Features the new mechanical torque adjustment locking device (M-TALD). An auto-locking single key operation prevents tampering.

Interchangeable end fittings for all models are available. Interchangeable Heads on page 03.23

Versatile wrench suitable for most applications. Ideal for use in hydraulic pipe work applications where open end or flare end wrenches are necessary.

ESD Compliant (IEC 613340-5-1:1998).

Model	Item #	Torque Ranges			Drive Type	Length		Weight		Break
		lbf.ft	N.m	kgf.m		in.	mm	lbs.	kg.	
STB35	020158	5.2 - 25	7 - 35	0.7 - 3.5	16mm Spigot	8 7/8"	225	1.1	0.49	110°
STB70	020159	14 - 51	20 - 70	2 - 7.1	16mm Spigot	14 1/3"	365	2	0.91	110°



NOTE!

For Signal Output (Electric Signal) and TALS (RF Transceiver) models see page 03.18.

MTBN

Break-Over Torque Wrench Internally Preset

KEY FEATURES

Designed and manufactured to meet or exceed the accuracy and repeatability requirements of ISO 6789:2003

- Tools < 10 N.m (± 6% of setting): MTBN 2 & MTBN 10
- Tools > 10 N.m (± 4% of setting): MTBN 25, MTBN 65 & MTBN 135

A preset production torque wrench. Breaks over upon reaching preset torque and reset automatically.

Tamper proof internal adjustment. No external adjustment scale – must be preset using a torque analyzer.

All models are fitted with “double positive” torque adjustment locking system to prevent tampering.

Compact and well balanced. Ideal for use in restricted areas.

Interchangeable end fittings for all models are available. Interchangeable heads on page 03.23

ESD compliant (IEC 61340-5-1:1998).

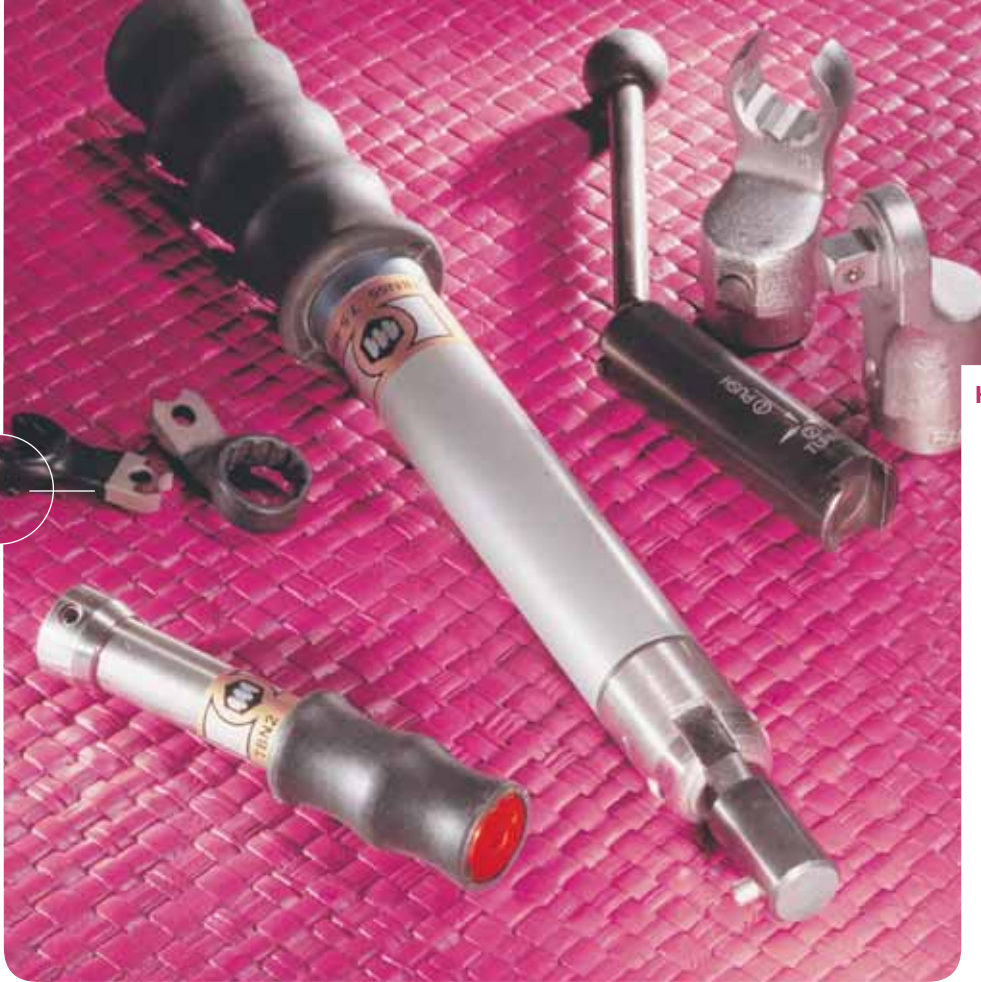

Model	Item #	Torque Ranges			Drive Type	Length		Weight		Break
		lbf.in	N.m	kgf.cm		in.	mm	oz.	gm.	
MTBN2	020314	1.8 - 18	0.2 - 2	2 - 20	Captive Pin	4.1	105	3.9	110	20° or 90°
MTBN10	020315	9 - 89	1 - 10	10 - 102	Captive Pin	4.1	105	4.6	130	20° or 90°
MTBN25*	020491	44 - 221	5 - 25	51 - 255	16mm Spigot	10.4	265	14.3	405	20°
MTBN25*	020333	44 - 221	5 - 25	51 - 255	Dovetail	10.4	265	14.3	405	20°
MTBN65*	020631	89 - 575	10 - 65	102 - 663	16mm Spigot	11.9	302	26.5	750	20°
MTBN65*	020353	89 - 575	10 - 65	102 - 663	Dovetail	11.9	302	26.5	750	20°
MTBN135*	020632	177 - 1194	20 - 135	204 - 1377	16mm Spigot	16.1	408	36.4	1030	20°
MTBN135*	020354	177 - 1194	20 - 135	204 - 1377	Dovetail	16.1	408	36.4	1030	20°

*Models operate in single direction (clockwise).



HANGING LOOP

Replace end cap of MTBN with a “Loop” end cap for hanging the wrench safely when it is not being used. Sold separately.

Model	Item #
MTBN2	020587
MTBN10	020587
MTBN25	020588
MTBN65	020589
MTBN135	020589

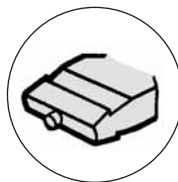

DOVETAIL END FITTINGS

Can be used with Sturtevant Richmond heads.

BREAK DIAGRAMS

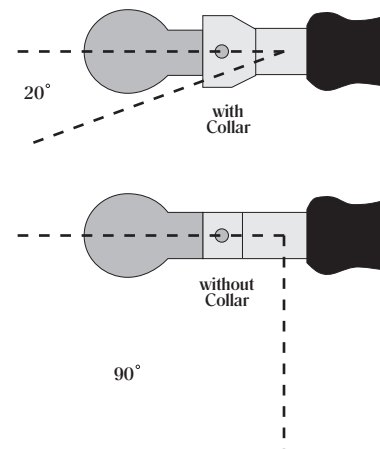

MTBN2 and MTBN10 are supplied with a removable collar, which restricts the “break” angle to 20°. If the collar is removed, the “break” angle increases to 90°.



NOTE!

For Signal Output (Electric Signal) and TALS (RF Transceiver) models see page 03.18.

MMTB

Miniature Break-Over Wrench with Fixed Heads

Designed and manufactured to meet or exceed the accuracy and repeatability requirements of ISO 6789:2003 ($\pm 6\%$ of setting).

"Breaks-over" when preset torque is reached eliminating overtorquing.

The break-over mechanism minimizes shock to assemblies.

Tamper-proof internal adjustment. No external adjustment scale – must be preset using a torque analyzer.

Torque ranges from 1 ozf.in to 80 ozf.in.

One-way operation standard.

Bi-directional break and calibration available.

Small and lightweight aluminum handle (3/8" dia. x approx. 3 1/2" overall length).

HEAD STYLES (additional sizes and special heads available)

OE (Open End) Sizes 7/32" to 3/4"

BH (Box Head) Sizes 1/4" to 3/4"

FN (Flare Nut) Sizes 1/4" to 9/16"

HK (Hex Key) Sizes 1/16" to 5/32"

RH (Ratchet Head) Size 1/4"

RG (Roller Grip) provide size (samples preferred) & clearance issues.

WHEN ORDERING:

There are two torque range models available:

1 ozf.in - 39 ozf.in
40 ozf.in - 80 ozf.in

Example:

1. **Specify your requested pre-set torque:** 10 ozf.in*
(*Pre-set torque can be set from 1 ozf.in to 80 ozf.in)
2. **Specify head:** OE (Open End)
3. **Specify size:** 1/4"



LTT ANALYZER

Torque analyzer for calibrating and testing small hand tools and power tools.



BMX

Torque transducer for calibrating and testing small hand tools and power tools.

For Torque Analyzers and Calibration Equipment, ask for our "Torque Analyzer & Torque Measurement" Catalog.



MMTB s shown at actual size.

ROLLER GRIP HEAD

These are custom made; provide size information (sample preferred) and any clearance issues. Head can be used for round knurled or non-knurled nut(s) where gripping to tighten might damage the surface. Typically, for odd sizes and with no flats for a wrench head to grip. Also, can be used to tighten certain tube shapes that wouldn't collapse under torque pressure.



etorque.com

ISO 9001 and ISO 17025 Company

MMTB
03.7



TBIH

Break-Over Wrench Interchangeable Head Style

Handle Color

Item #	Item #	Item #	Item #	Item #	Item #	Torque Ranges
068000-A	068001-A	068002-A	068003-A	068004-A	067999-A	25 - 50 ozf.in
068000-B	068001-B	068002-B	068003-B	068004-B	067999-B	3 - 12 lbf.in
068000-C	068001-C	068002-C	068003-C	068004-C	067999-C	12 - 21 lbf.in
068000-D	068001-D	068002-D	068003-D	068004-D	067999-D	20 - 50 lbf.in

NOTE!

Torque is easily adjusted by removing the end cap and turning the adjustment screw with the 3/16" Hex Key (supplied). Then verify torque output using a torque analyzer.

Standard TBIH models have a "break" angle range up to 90°. For models that limit the "break" angle to 20° or 30°, available upon request.

KEY FEATURES

Designed and manufactured to meet or exceed the accuracy and repeatability requirements of ISO 6789:2003 (± 6% of setting).

"Breaks-over" when preset torque is reached eliminating overtorquing.

The break-over mechanism minimizes shock to assemblies.

Tamper-proof internal adjustment. No external adjustment scale - must be preset using a torque analyzer.

Torque ranges 25 ozf.in - 50 lbf.in. For smaller torque ranges see MMTB models.

Six different colored aluminum handles allow for color coding of specific torque values in production areas.

Small and lightweight. Ideal for use in restricted spaces.
Handle size: 5 1/2" L x 9/16" Dia.

Interchangeable heads are manufactured with a common center line so the torque setting remains the same when head sizes are changed.

TBIH also accepts Utica® "A" size heads.



Accessories
TB Bits
See Page
03.10

TB

Break-Over Wrench with Fixed Heads

KEY FEATURES

- Designed and manufactured to meet or exceed the accuracy and repeatability requirements of ISO 6789:2003 ($\pm 6\%$ of setting).
- "Breaks-over" when preset torque is reached eliminating overtorquing.
- The break-over mechanism minimizes shock to assemblies.
- Tamper-proof internal adjustment. No external adjustment scale - must be preset using a torque analyzer.
- Torque ranges 25 ozf.in - 50 lbf.in.
- Six different colored aluminum handles allow for color coding of specific torque values in production areas.
- Small and lightweight. Handle: 5" L x 9/16" Dia.

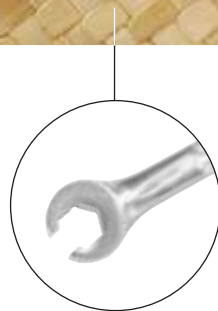

TB FIXED HEADS

To configure the TB fixed head wrench, select Handle part number below and then select Head part number on page 03.10
Order Example: #06004C - 156

Handle Color

Item #	Item #	Item #	Item #	Item #	Item #	Torque Ranges
06001A	06002A	06003A	06004A	06005A	06006A	25 - 50 ozf.in
06001B	06002B	06003B	06004B	06005B	06006B	3 - 12 lbf.in
06001C	06002C	06003C	06004C	06005C	06006C	12 - 21 lbf.in
06001D	06002D	06003D	06004D	06005D	06006D	20 - 50 lbf.in



BREAK-OVER FEATURE

When the TB wrench achieves torque, the head breaks-over preventing the operator from overtorquing the fastener.

NOTE!

Torque is easily adjusted by removing the end cap and turning the adjustment screw with the 3/16" Hex Key (supplied). Then verify torque output using a torque analyzer.
Standard TB models have a "break" angle range up to 90°. For models that limit the "break" angle to 20° or 30°, available upon request.

Heads

TBIH Interchangeable & TB Fixed

OPEN END



AMERICAN

Size in.	TBIH Item #	TB Item #
5/64	068115	115
1/8	068100	100
9/64	068180	180
5/32	068101	101
3/16	068102	102
13/64	068314	314
7/32	068103	103
15/64	068215	215
1/4	068104	104
9/32	068105	105
5/16	068106	106
11/32	068107	107
3/8	068108	108
13/32	068098	098
7/16	068109	109
1/2	068110	110
9/16	068111	111
5/8	068112	112
11/16	068114	114
3/4	068113	113
13/16	068099	099
7/8	068042	042

METRIC

Size mm	TBIH Item #	TB Item #
3	068159	159
4	068202	202
5	068139	139
5.5	068046	046
6	068140	140
6.5	068160	160
7	068141	141
8	068142	142
8.5	068149	149
9	068143	143
10	068144	144
11	068145	145
12	068146	146
13	068147	147
14	068148	148
15	068136	136
17	068237	237
18	068222	222
19	068208	208
20	068199	199
21	068138	138
22	068209	209

BOX END



AMERICAN

Size in.	TBIH Item #	TB Item #
1/8	068120	120
5/32	068121	121
3/16	068122	122
7/32	068123	123
1/4	068124	124
9/32	068125	125
5/16	068126	126
11/32	068127	127
3/8	068128	128
7/16	068129	129
1/2	068130	130
9/16	068131	131
5/8	068132	132
11/16	068133	133
3/4	068134	134

METRIC

Size mm	TBIH Item #	TB Item #
5	068313	313
6	068150	150
7	068151	151
8	068152	152
9	068153	153
10	068154	154
11	068155	155
12	068156	156
13	068157	157
17	068137	137

HEX KEY



AMERICAN

Size in.	TBIH Item #	TB Item #
1/16	068174	174
5/64	068162	162
3/32	068163	163
7/64	068164	164
1/8	068165	165
9/64	068166	166
5/32	068167	167
3/16	068168	168
7/32	068169	169
1/4	068170	170
3/8	068171	171
7/16	068172	172
3/4	068173	173

METRIC

Size mm	TBIH Item #	TB Item #
0.05	068175	175
1.5	068236	983
2	068181	181
2.5	068182	182
3	068183	183
3.5	068184	184
4	068185	185
5	068186	186

FLARE END



AMERICAN

Size in.	TBIH Item #	TB Item #
1/4	068188	188
5/16	068189	189
3/8	068187	187
7/16	061553	553
1/2	068198	198
9/16	068190	190
11/16	068320	320
3/4	068235	235
13/16	068321	321

METRIC

Size mm	TBIH Item #	TB Item #
13	068232	232
15	068194	194
17	068355	355
19	068298	298

TB Bits

Adapters for Ratchet Heads

SLOTTED HEAD ADAPTERS



Model	Item #	Bit Width
CM-25	120035	3/16"
CM-26	120374	7/32"
CM-17	120031	1/4"
CM-19	120375	3/8"

Package Quantity: 10

HEX HEAD ADAPTERS



AMERICAN

Model	Item #	Size in.
CMS-3	120366	0.050
CMS-4	120367	1/16
CMS-5	120368	5/64
CMS-6	120036	3/32
CMS-7	120037	7/64
CMS-8	120369	1/8
CMS-9	120038	9/64
CMS-10	120039	5/32
CMS-12	120370	3/16
CMS-14	120371	7/32
CMS-16	120372	1/4
CMS-18	120373	5/16

PHILLIPS HEAD ADAPTERS



Model	Item #	Point Size
CMP-20	120032	No. 1
CMP-21	120033	No. 2
CMP-33	120376	No. 3

Package Quantity: 10

SQUARE DRIVE ADAPTERS



Model	Item #	Size in.
CM-24	120034	1/4

Package Quantity: 10

METRIC

Model	Item #	Size mm
CMS-40	120040	1.5
CMS-41	120041	2.0
CMS-42	120042	2.5
CMS-43	120043	3.0
CMS-44	120044	4.0
CMS-45	120045	5.0

Package Quantity: 10

REED & PRINCE ADAPTERS



Model	Item #	Point Size
CM-37	120377	No. 2

Package Quantity: 10

RATCHET

Size in.	TBIH Item #	TB Item #
1/4 Hex	068195	195

ROLLER GRIP HEAD

These are custom made; provide size information (sample preferred) and any clearance issues. Head can be used for round knurled or non-knurled nut(s) where gripping to tighten might damage the surface. Typically, for odd sizes and with no flats for a wrench head to grip. Also, can be used to tighten certain tube shapes that wouldn't collapse under torque pressure.



Titan

Click Wrench (Adjustable)

Designed and manufactured to meet or exceed the accuracy and repeatability of ISO 6789:2003 ($\pm 4\%$ of setting).

Adjustable torque wrench available with square drive models and 16mm Spigot models.

Square drive models feature a bi-directional ratchet head.

Easy-to-read dual scale (American & S.I.) protected by a display window. Graduation collar on the torque handle.

Crafted with strong steel shaft with high corrosion resistance. The handle is shaped to provide a firm, ergonomic grip.

Features a "Push-Button Locking Device". It securely locks the preset torque and prevents inadvertent adjustment.

Supplied with a certificate of calibration.

Positive "click" can be heard and felt when torque is reached.

Model	Item #	Torque Ranges		Drive Size
		American	N.m	
Titan100i	280010	20 - 100 lbf.in	2.3 - 11.3	1/4" Sq. Dr.
Titan250i	280011	50 - 250 lbf.in	5.6 - 28.2	3/8" Sq. Dr.
Titan250i-S	280021	50 - 250 lbf.in	5.6 - 28.2	16mm Spigot
Titan75F	280012	10 - 75 lbf.ft	13.5 - 101.6	3/8" Sq. Dr.
Titan75F-S	280022	10 - 75 lbf.ft	13.5 - 101.6	16mm Spigot
Titan150F	280013	30 - 150 lbf.ft	40.6 - 203.3	1/2" Sq. Dr.
Titan150F-S	280023	30 - 150 lbf.ft	40.6 - 203.3	16mm Spigot
Titan300F	280014	60 - 300 lbf.ft	81.3 - 406.7	1/2" Sq. Dr.
Titan300F-S	280024	60 - 300 lbf.ft	81.3 - 406.7	16mm Spigot
Titan600F	280015	120 - 600 lbf.ft	162.7 - 813.5	3/4" Sq. Dr.

Model	Graduation		Length		Weight	
	Scale	Collar	in.	mm	lbs.	kg.
Titan100i	5 lbf.in	-	12	307	1.1	0.5
Titan250i	10 lbf.in	1 lbf.in	13.8	350	1.3	0.6
Titan250i-S	10 lbf.in	1 lbf.in	13.2	335	1.1	0.5
Titan75F	2.5 lbf.ft	0.25 lbf.ft	15.5	395	2	0.9
Titan75F-S	2.5 lbf.ft	0.25 lbf.ft	14.8	375	1.3	0.6
Titan150F	5 lbf.ft	0.5 lbf.ft	19.1	485	2.5	1.1
Titan150F-S	5 lbf.ft	0.5 lbf.ft	18.3	465	1.8	0.8
Titan300F	10 lbf.ft	1 lbf.ft	26.2	665	3.5	1.6
Titan300F-S	10 lbf.ft	1 lbf.ft	25.6	650	3.5	1.6
Titan600F	10 lbf.ft	1 lbf.ft	48.8	1240	11.5	5.2



HEADS

16mm Spigot models allows for Open, Box, Flare and Ratchet Heads.

See Page 03.23



SMX TRANSDUCER

Connect the SMX to the square drive of the Titan wrench and monitor the torque applied. For Torque Transducers, ask for our "Torque Analyzer & Torque Measurement" Catalog.

NOTE!

After being used, torque click wrenches should be turned back to the minimum scale value. This helps to preserve the springs and ensures a longer product life cycle with high precision.



Torque Wrenches



DM

Lightweight Click Wrench (Adjustable)



Single or double square drive models.

Model	Item #	Square Drive	Torque Ranges		Graduation	
			American	S.I.	American	S.I.
DM 12	110100	Single	18 - 106 lbf.in	2 - 12 N.m	5 lbf.in	0.5 N.m
DM 30	110115	Single	50 - 270 lbf.in	6 - 30 N.m	10 lbf.in	1 N.m
DM 30-D	110121	Double	50 - 270 lbf.in	6 - 30 N.m	10 lbf.in	1 N.m
DM 40	110102	Single	70 - 350 lbf.in	8 - 40 N.m	50 lbf.in	5 N.m
DM 40-D	110122	Double	70 - 350 lbf.in	8 - 40 N.m	50 lbf.in	5 N.m
DM 120	110103	Single	15 - 90 lbf.ft	20 - 120 N.m	5 lbf.ft	5 N.m
DM 120-D	110108	Double	15 - 90 lbf.ft	20 - 120 N.m	5 lbf.ft	5 N.m
DM 200	110110	Single	30 - 150 lbf.ft	40 - 200 N.m	5 lbf.ft	5 N.m
DM 200-D	110114	Double	30 - 150 lbf.ft	40 - 200 N.m	5 lbf.ft	5 N.m
DM 300	110104	Single	35 - 220 lbf.ft	50 - 300 N.m	5 lbf.ft	5 N.m
DM 300-D	110113	Double	35 - 220 lbf.ft	50 - 300 N.m	5 lbf.ft	5 N.m
DM 360	110127	Single	60 - 260 lbf.ft	80 - 360 N.m	5 lbf.ft	5 N.m
DM 360-D	110129	Double	60 - 260 lbf.ft	80 - 360 N.m	5 lbf.ft	5 N.m
DM 550	110130	Single	80 - 405 lbf.ft	110 - 550 N.m	10 lbf.ft	10 N.m
DM 550-D	110135	Double	80 - 405 lbf.ft	110 - 550 N.m	10 lbf.ft	10 N.m
DM 760	110105	Single	105 - 560 lbf.ft	140 - 760 N.m	10 lbf.ft	10 N.m
DM 760-D	110136	Double	105 - 560 lbf.ft	140 - 760 N.m	10 lbf.ft	10 N.m
DM 1000	110106	Single	380 - 730 lbf.ft	520 - 1000 N.m	10 lbf.ft	10 N.m
DM 1000-D	110137	Double	380 - 730 lbf.ft	520 - 1000 N.m	10 lbf.ft	10 N.m
DM 2000	110107	Single	553 - 1475 lbf.ft	750 - 2000 N.m	*	50 N.m
DM 2000-D	110138	Double	553 - 1475 lbf.ft	750 - 2000 N.m	*	50 N.m
DM 3000	110150	Single	1106 - 2212 lbf.ft	1500 - 3000 N.m	*	50 N.m

* DM 2000 & DM 3000 models are only available as a single scale model - N.m



RATCHET ADAPTER

Enables controlled tightening in combination with DM Series wrenches.
See Page 03.24

KEY FEATURES

Designed and manufactured to meet or exceed the accuracy and repeatability of ISO 6789:2003 ($\pm 4\%$ of setting).

Lightweight design crafted with high-strength aluminum alloy. Full-metal construction (except DM12).

DM12 model crafted with lightweight, high-grade glass-fiber reinforced polyamide, with soft-grip handle.

Non-length dependent.

Ergonomically designed handgrip enables simple and safe operations.

Adjustable torque wrench available with single or double square drive.

Single square drive for controlled clockwise tightening.
Double square drive for controlled bi-directional tightening.

Setting of the torque by non-losable hexagon key in the handgrip. The smooth-running mechanism enables the setting to be made quickly without significant force needing to be applied.

Easy-to-read dual scale (American & S.I.) with a graduation scale. Except DM 2000 & 3000 models - N.m scale only.

Positive "click" can be heard and felt when torque is reached.

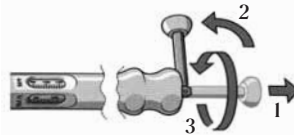

Setting the torque by non-losable hexagon key in the handgrip. The smooth-running mechanism enables the setting to be made quickly without significant force.

Model	Square Drive	Length		Weight	
		in.	mm	lbs.	kg.
DM 12	1/4"	8 1/3"	211	0.6	0.25
DM 30	1/4"	10 1/2"	265	1.3	0.58
DM 30-D	1/4"	10 1/2"	265	1.3	0.58
DM 40	3/8"	13 3/8"	340	2.2	1
DM 40-D	3/8"	13 3/8"	340	2.2	1
DM 120	1/2"	18 1/4"	463	3.3	1.5
DM 120-D	1/2"	18 1/4"	463	3.3	1.5
DM 200	1/2"	21 3/4"	553	3.1	1.4
DM 200-D	1/2"	21 3/4"	553	3.1	1.4
DM 300	1/2"	24 1/3"	618	4.4	2
DM 300-D	1/2"	24 1/3"	618	4.4	2
DM 360	3/4"	28 1/4"	718	5.3	2.4
DM 360-D	3/4"	28 1/4"	718	5.3	2.4
DM 550	3/4"	32"	812	6.4	2.9
DM 550-D	3/4"	32"	812	6.4	2.9
DM 760	3/4"	32"	812	7.1	3.2
DM 760-D	3/4"	32"	812	7.1	3.2
DM 1000	3/4"	*55 1/8" +	*1400 +	12.4	5.6
DM 1000-D	3/4"	*55 1/8" +	*1400 +	12.4	5.6
DM 2000	1"	*78 2/3" +	*1988 +	25.6	11.6
DM 2000-D	1"	*78 2/3" +	*1988 +	25.6	11.6
DM 3000	1 1/2"	*92 1/4" +	*2343 +	29.1	13.2

* Models come with an extension tube.



NOTE!

After being used, torque click wrenches should be turned back to the minimum scale value. This helps to preserve the springs and ensures a longer product life cycle with high precision.



Insulated

Torque Wrenches

KEY FEATURES

Designed and manufactured to meet or exceed the accuracy and repeatability requirements of ISO 6789:2003 ($\pm 4\%$ of setting).

May be used for torque on battery terminals.

Reduces possibility of shorting or shock.

PVC heat shrink insulation.

Non-conductive plastic grip handles.

For use on electrical systems up to 50 volts (SLO and MTBN models).

For use on electrical systems up to 1000 volts (TSN models).



ISO CERTIFIED COMPANY

Mountz is a ISO 9001 and ISO 17025 registered company dedicated to manufacturing and servicing high quality torque tools.

TSN - INTERNALLY PRESET

Model	Item #	Torque Ranges		Square Drive	Length		Weight	
		lbf.ft	N.m		in.	mm	oz.	kg.
TSN25DI	020271	2 - 18	3 - 25	1/4"	8 7/8	226	15	0.42
TSN25AI	020272	2 - 18	3 - 25	3/8"	8 7/8	226	15	0.42
TSN55I	020273	10 - 40	15 - 55	3/8"	13	333	35	0.98
TSN125I	020274	30 - 90	40 - 125	1/2"	18 3/8	466	56	1.58

SLO - EXTERNALLY ADJUSTABLE

Model	Item #	Torque Ranges		Sq. Drive	Ratchet Dia.		Length		Weight	
		lbf.in	N.m		in.	mm	in.	mm	lbs.	kg.
SLO1/4I	060398	40 - 180	4 - 20	1/4"	1 1/2	38	8 5/8	220	1.3	0.6
SLO3/8I	060113	40 - 180	4 - 20	3/8"	1 1/2	38	8 5/8	220	1.3	0.6

MTBN - INTERNALLY PRESET

Model	Item #	Torque Ranges		Sq. Drive	Length		Weight	
		lbf.in	N.m		in.	mm	oz.	g.
MTBN2I	020592	1.8 - 18	0.2 - 2	1/4"	4 1/8	105	5.9	168
MTBN10I	020593	9 - 89	1 - 10	1/4"	4 1/8	105	5.9	168

NOTE!

Meets IEC900 Standards.
When ordering the TSN and MTBN models, the preset torque value must be provided.

STW

Springless Click Wrench (Adjustable)

KEY FEATURES

Designed and manufactured to meet or exceed the accuracy and repeatability of ISO 6789:2003 ($\pm 4\%$ of setting).

Most externally adjustable click type wrenches must be returned to the lowest setting after use in order to minimize potential spring set, which can adversely affect reproducibility at other settings. A patent springless design of the STW wrench is not subject to potential spring set, which eliminates the need for the click wrench to be turned back to the minimum scale value after being used.

Adjustable torque wrench available with square drive models and 16mm Spigot models.

Square drive models feature a bi-directional ratchet head.

16mm Spigot models allows for interchangeable end fittings.

Quick and precise slide adjustment. Easily set the desired torque by unscrewing the side knob and gliding the slider on the scale to the required value.

The handle is crafted to provide a firm, ergonomic grip.

Positive "click" can be heard and felt when torque is reached.



Easy-to-read dual scale (American & S.I.) protected by a display window.

Model	Item #	Torque Ranges	
		American	S.I.
STW50	280200	7 - 50 lbf.ft	10 - 70 N.m
STW50-S	280201	7 - 50 lbf.ft	10 - 70 N.m
STW75	280202	15 - 75 lbf.ft	20 - 100 N.m
STW75-S	280203	15 - 75 lbf.ft	20 - 100 N.m
STW150	280204	30 - 150 lbf.ft	40 - 200 N.m
STW150-S	280205	30 - 150 lbf.ft	40 - 200 N.m
STW300	280206	50 - 300 lbf.ft	70 - 400 N.m
STW300-S	280207	50 - 300 lbf.ft	70 - 400 N.m

inches DIMENSIONS AND WEIGHT

Model	Drive Size	Length		Weight	
		in.	mm	lbs.	kg.
STW50	1/2 Sq. Dr.	15	380	2.2	1
STW50-S	16mm Spigot	14 3/4	375	2.2	1
STW75	1/2 Sq. Dr.	17 3/4	450	2.6	1.2
STW75-S	16mm Spigot	17 1/8	435	2.4	1.1
STW150	1/2 Sq. Dr.	17 3/4	450	2.6	1.2
STW150-S	16mm Spigot	17 1/8	435	2.4	1.1
STW300	1/2 Sq. Dr.	23 1/4	590	3.3	1.5
STW300-S	16mm Spigot	22 1/2	570	3.1	1.4



HEADS

16mm Spigot models allows for Open, Box, Flare and Ratchet Heads.
See Page 03.23



LTT ANALYZER

For Torque Analyzers, ask for our "Torque Analyzer & Torque Measurement" Catalog.

TorqueMate® Wrench

Electronic Torque Wrench

Accuracy ± 1% of reading from 10% to 100% of full scale.

Microprocessor controlled digital memory wrench for delivering precision torque and storing & downloading torque readings.

Ideal for torque measurement and auditing in R&D, QC, a lab, maintenance and production areas.

RS-232 bi-directional USB cable for data transfer - Windows, MS Excel, SPC compatible.
Additional download can be made in ASCII or binary format.

Bi-directional operation with built-in ratchet head.

Programmable pre-sets up to 99 pre-sets of torque or torque & angle* can be programmed on wrench or uploaded from PC (software provided), all with individual minimum and maximum limits or percentage tolerances. Audible and visual alarms signal approach and achievement of preset torque values.

Over torque warning system.

The recalibration period can be set by cycles and/or time.

Can store torque readings with a time and date stamp.

Selectable languages and units of measurement.

For angle models, both torque and angle values are displayed simultaneously.

Model	Measures	Item #	Torque Ranges		Square Drive	Length		Weight	
			lbf.ft	N.m		inches	mm	lbs.	kg.
TMW20	Torque	240150	1.4 - 14	2 - 20	1/4"	16 1/8	410	1.5	0.67
TMW20A	Torque & Angle	240151	1.4 - 14	2 - 20	1/4"	16 1/8	410	1.5	0.67
TMW50	Torque	240152	3.6 - 36	5 - 50	3/8"	16 1/3	415	1.6	0.73
TMW50 A	Torque & Angle	240153	3.6 - 36	5 - 50	3/8"	16 1/3	415	1.6	0.73
TMW100	Torque	240154	7.3 - 73	10 - 100	3/8"	16 1/3	415	1.6	0.73
TMW100A	Torque & Angle	240155	7.3 - 73	10 - 100	1/2"	16 1/3	415	1.6	0.73
TMW150	Torque	240156	11 - 110	15 - 150	1/2"	22 1/2	570	2.6	1.2
TMW150A	Torque & Angle	240157	11 - 110	15 - 150	1/2"	22 1/2	570	2.6	1.2
TMW250	Torque	240158	18 - 180	25 - 250	1/2"	22 1/2	570	2.6	1.2
TMW250A	Torque & Angle	240159	18 - 180	25 - 250	1/2"	22 1/2	570	2.6	1.2

SPECIFICATIONS

Operation Modes Peak, Pre-set, Set, Recall, Upload, Clear, Date, Language, Units, Track, Backlite, Com (First Movement*, Torque & Angle*)

Units ozf.in, lbf.in, lbf.ft, cN.m, N.m, kgf.cm, kgf.m

Alarms Preset Value Approach, Fastener Overload, Range Overload, Mechanical Overload, Low Battery, Memory Full.

Data Memory 2094 values

Power 4 x AA Batteries

Display Digits Four

Languages English, French, German, Italian, Portuguese & Spanish

* For Torque & Angle Models only.



BMX TRANSDUCER

For calibrating manual tools, power tools or special applications.
A wide torque range selection, from 2 ozf.in to 20,000 lbf.ft.

See Our Torque Analyzer & Test Measurement Catalog



Torque
Wrenches

RETW

Electronic Torque Wrench

KEY FEATURES

- Accuracy $\pm 2\%$ of reading ± 1 digit.
- Designed for daily screw tightening production environment.
- Program pre-set torque.
- Rotating head allows viewing of the display from any angle.
- Three units of torque measurement available: N.m, lbf.ft, lbf.in
- Selection of two operating modes: Track and Peak.
- Heavy duty ratchet head.
- Go/No Go LED's and a buzzer can be set for high or low torque limits.
- Four-digit display.
- Battery operation (Optional - Rechargeable Battery Adapter Kit).
- Optional RS-232 serial interface to download torque readings to a PC or printer in real-time.

Model	Item #	Torque Ranges		Length		Drive Type	Weight	
		American	S.I.	in.	mm		lbs.	kg.
RETW250i	290106	25 - 250 lbf.in	3 - 30 N.m	15	381	3/8" Sq Dr.	2.2	0.9
RETW100F	290107	10 - 100 lbf.ft	13.6 - 135.6 N.m	17	431	3/8" Sq Dr.	2.4	1.1
RETW150F	290108	15 - 150 lbf.ft	20.3 - 203.3 N.m	19	480	1/2" Sq Dr.	2.8	1.3
RETW250F	290109	25 - 250 lbf.ft	33.9 - 339 N.m	22	550	1/2" Sq Dr.	3	1.4



NOTE!

- Uses standard AA batteries (if not using Rechargeable Battery Adapter Kit accessory)
- Do not place alkaline batteries into Battery Charging Kit accessory. Only use rechargeable batteries with the kit.

RS-232 RECHARGEABLE BATTERY ADAPTER KIT

Item #290114

- RS-232 serial interface to download torque readings in real-time.
- Does not store any readings.
- Battery charger: ONLY use rechargeable batteries with the kit.



800.456.1828



EDTW

Electronic Dial Torque Wrench

KEY FEATURES

- Accuracy $\pm 1\%$ of reading, ± 1 digit.
- Designed for R&D, QC, a lab or production environment.
- Program pre-set torque.
- Display rotates both directions up to 359° - LCD can be read from any side.
- Three units of torque measurement available: N.m, lbf.ft, lbf.in.
- Selection of two operating modes: Track and Peak.
- Non-length dependent.
- Go/No Go LED's and a buzzer can be set for high or low torque limits.
- Four-digit display.
- Battery operation.

Display rotates both ways (up to 359°).



Model	Item #	Torque Ranges	
		American	S.I.
EDTW75i	290100	7.5 - 75 lbf.in	0.8 - 8.5 N.m
EDTW100i	290101	10 - 100 lbf.in	1.1 - 11.3 N.m
EDTW250i	290102	25 - 250 lbf.in	2.8 - 28.2 N.m
EDTW50F	290103	5 - 50 lbf.ft	6.8 - 67.8 N.m
EDTW250F	290104	25 - 250 lbf.ft	33.9 - 339 N.m
EDTW600F	290105	60 - 600 lbf.ft	81.3 - 813.5 N.m

Model	Square Drive	Length		Weight	
		in.	mm	lbs.	kg.
EDTW75i	1/4"	10.6	270	1.6	0.73
EDTW100i	1/4"	10.6	270	1.6	0.73
EDTW250i	3/8"	10.6	270	1.6	0.73
EDTW50F	3/8"	10.6	270	1.6	0.73
EDTW250F	1/2"	22	560	3	1.4
EDTW600F	3/4"	47	1193.8	10	4.5

NOTE!

Uses standard 9v battery.
These units only display the digital torque readings as there is no memory capacity to store and download data.

Push Rod Tools

Create your own Signal Output or TALS-2 Wireless Wrench

SIGNAL OUTPUT WRENCH
(3 Components - SOLD Separately)



TALS-2 WIRELESS WRENCHES
(2 Components - SOLD Separately)



KEY FEATURES

The Push Rod (PR) tools are the common wrench component used for the Signal Output Wrench and the TALS-2 Wireless Wrench. The appropriate Universal Rotary Switch Module or Universal Tool RF Transceiver must be added prior to use.

PR wrenches are designed with a "Push Rod" connected to the mechanism of the wrench. When the wrench achieves its set torque, the rod makes contact with the microswitch housed within the Rotary Switch Module or RF Transceiver Module.

Designed and manufactured to meet or exceed the accuracy and repeatability requirements of ISO 6789:2003

- Tools < 10 N.m ($\pm 6\%$ of setting):

MTBN2-PR & MTBN10-PR, TSP5/45-PR, TSP10/90-PR

- Tools > 10 N.m are ($\pm 4\%$ of setting):

MTBN25-PR, MTBN65-PR & MTBN135-PR, TSN25D-PR, TSN25A-PR, TSN55-PR, TSN125-PR, STB35-PR & STB70-PR

TSN - PUSH ROD WRENCH

(Cam-Over Wrench style)

Model	Item #	Torque Ranges			Length		Square Drive	Weight	
		lbf.ft	N.m	kgf.m	inches	mm		oz.	gm.
TSN25D-PR	020500	2 - 18	3 - 25	.3 - 2.5	9 3/4	247	1/4"	13.8	390
TSN25A-PR	020504	2 - 18	3 - 25	.3 - 2.5	9 3/4	247	3/8"	13.8	390
TSN55-PR	020502	10 - 40	15 - 55	1.5 - 5.6	13	328	3/8"	30.1	850
TSN125-PR	020503	30 - 90	40 - 125	4 - 12.7	18 1/4	464	1/2"	50.8	1430

MTBN - PUSH ROD WRENCH

(Break-Over Wrench style)

Model	Item #	Torque Ranges			Length		Drive Type	Weight		
		lbf.in	N.m	kgf.m	inches	mm		oz.	gm.	Break
MTBN2-PR	020538	1.8 - 18	0.2 - 2	2 - 20	5 3/4	147	Captive Pin	5.7	160	20° or 90°
MTBN10-PR	020539	9 - 89	1 - 10	10 - 102	5 3/4	147	Captive Pin	6.4	180	20° or 90°
MTBN25-PR*	020494	44 - 221	5 - 25	51 - 255	10 3/8	270	16mm Spigot	16.3	460	20°
MTBN65-PR*	020495	89 - 575	10 - 65	102 - 663	13 1/2	345	16mm Spigot	29	820	20°
MTBN135-PR*	020505	177 - 1195	20 - 135	204 - 1377	17 1/8	435	16mm Spigot	38.2	1080	20°

*Models operate in single direction (clockwise).

STB - PUSH ROD WRENCH

(Cam-Over Breaking Wrench style)

Model	Item #	Torque Ranges			Length		Drive Type	Weight		
		lbf.ft	N.m	kgf.m	inches	mm		oz.	gm.	Break
STB35-PR	020575	5.2 - 25	7 - 35	0.7 - 3.5	10	256	16mm Spigot	19.1	540	110°
STB70-PR	020576	14 - 51	20 - 70	2 - 7.1	14 1/2	369	16mm Spigot	34	960	110°

TSP - PUSH ROD WRENCH

(Cam-Over Wrench style)

Model	Item #	Torque Ranges			Length		Square Drive	Weight	
		lbf.in	N.m	kgf.m	inches	mm		oz.	gm.
TSP5/45-PR	020537	10 - 45	1 - 5	10.2 - 51	7 7/8	200	1/4"	8.5	240
TSP10/90-PR	020549	20 - 90	20 - 90	20.4 - 102	7 7/8	200	1/4"	8.5	240



NOTE!

The weight and length does not include the Universal Rotary Switch Model or TALS Transceiver attached to the wrenches.

SIGNAL OUTPUT WRENCHES (Electric Signal Wrenches)



Push Rod Wrench
Item # (Select from previous page)

Requires 3 components:



Universal Rotary Switch Module
Item #20-B25900



Straight Cable (pictured) Item #20-D94402
Spiral Cable Item #20-D94406

KEY FEATURES

Push Rod Tools are fitted with a Universal Rotary Switch Module (360° rotating connector prevents twisting or kinking of the cable), which signals when a pre-set torque value is reached.

Signal Output Wrenches can be connected to a Signal Delay Unit (accessory item) to monitor the use of the wrenches as the electrical signal is displayed each time the wrench achieves its pre-set torque value.

Micro-switch contained in internal shock-resistant housing.

Signal Output Wrenches can be interfaced with computers, counters, or gate switch.

Possible use in Production Line Control: Allowing only components with correctly torque fasteners to pass through a work station. This could be a simple matter of actuating a gate switch or signaling a computer controlled work station.

Counting Function: Count the number of times the torque has been applied - check against finished goods.

ACCESSORIES

SIGNAL DELAY UNIT Item #20-C12870



Designed to exceed the duration of the electrical circuit completed and guarantee interface quality. It minimizes risk of multiple signals caused by rapid use or variable signal duration. The wall mountable box features adjustable signal duration and LEDs to monitor the signal.

POWER SUPPLY FOR SIGNAL DELAY UNIT

Item #020618

TALS-2 WIRELESS WRENCHES



Push Rod Wrench
Item # (Select from previous page)

Requires 2 components:

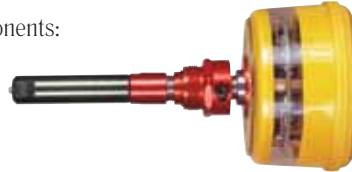

Universal Tool RF Transceiver
Item #020533

Connected to Push Rod Wrench to create a wireless wrench. Transmit signals to UIB (User Interface Box) each time wrench reaches pre-set torque.

KEY FEATURES

Wireless torque application monitoring system designed to send signal to an external monitoring device when a preset torque has been applied.

Use TALS as on-line monitoring of critical fasteners in a production line to ensure the line will only move when the required number of fastening operations have been confirmed.

Two way communication between the wrench and user interface box, plus remote antennae; can be positioned close to the production area and provide reliable signal.

Work without the hassle of cables and deliver accurate torque.

Perfect for remote switching, counting, batching, production line control, auditing, and monitoring.

RS-232 interface to download readings and wrench data for easy SPC analysis and quality control documents.

TALS-2 CORE SYSTEM



UIB
(User Interface Box)

KEY FEATURES

Designated to capture signals by the wrenches fitted with RF Transceivers.

Up to 4 wireless wrenches can be monitored simultaneously. Large liquid crystal display allows operator to view: wrench transceiver serial number, battery status, shift count, last calibration count, and relay time delay. Can add up to 3 more nodes.

TALS-2 CORE SYSTEM

Item #020540

Consists of the following:

- 1 User Interface Box
- 2 Node Transceivers
- 2 Circuit Terminators
- 2 Node Cables

TALS POWER SUPPLY

Item #061629



NODE TRANSCEIVER

Item #020534

Contains a radio transceiver to communicate with wrench transceiver. Nodes are hard wired into UIB, a minimum of 2 nodes are needed and maximum of 5 are possible. Two Nodes included with Core system. Additional Nodes may be needed in production area.

TOOL RF TRANSCEIVER BATTERY

Item #770495

Three required per transceiver.



CIRCUIT TERMINATOR FOR INTERFACE BOX

Item #020536

Circuit Terminator - Two included with TALS-2 Core System (Only two required, one for each transceiver channel). Only reason to buy separately would be if one became damaged or lost.

TALS TRANSCEIVER PROTECTIVE COVER

Item #020591

Dial Measuring

Torque Wrenches
ADS - EDS

KEY FEATURES

Designed and manufactured to meet or exceed the accuracy and repeatability requirements of ISO 6789:2003

- Tools < 10 N.m (\pm 6% of setting): ADS4 & ADS8 models.
- Tools > 10 N.m (\pm 4% of setting): All other Dial Wrench models.

For controlled screw tightening and torque measurements.

Non-length dependent.

Dual scale in American and S.I. units. Single scale models are available.

Fine main and memory pointers provide accurate readings.

Exclusive built-in ratchet mechanism.

Standard double-ended spindle ratchet mechanism allows for CW & CCW torque applications.

EDS models fitted with fixed double-end square drive.

Single-end spindles available upon request.

Lightweight aluminum handle (w/non-slip grip) for improved balance. Scuff-resistant non-slip finish.

Quality constructed for accuracy and reliability with an attractive abrasive resistant finish for longer life.

Mechanical stop provides overload protection to 125% of full scale.

Recessed dial minimizes dial breakage.

Model serial numbers labeled for instant traceability / identification.

Torque indicating signal light - standard on CDS, DDS, and EDS models. Optional on certain ADS and BDS models.

ADS models are ESD compliant (IEC 61340-5-1:1998).

BDS, CDS, DDS and EDS models are available in ESD upon request.

Torque Wrenches

ADS - EDS
03.20



800.456.1828



Working Principle of Dial Measuring Torque Wrenches

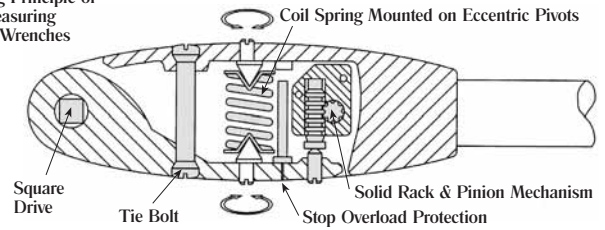

Model	Item #	Calibrated Torque Ranges		Graduation	
		American	S.I.	American	S.I.
ADS4	020100	7 - 35 lbf.in	0.8 - 4 N.m	1 lbf.in	0.1 N.m
ADS8	020101	14 - 70 lbf.in	1.6 - 8 N.m	1 lbf.in	0.25 N.m
ADS12D	020102	24 - 120 lbf.in	2.4 - 12 N.m	2 lbf.in	0.5 N.m
ADS12A	020103	24 - 120 lbf.in	2.4 - 12 N.m	2 lbf.in	0.5 N.m
ADS25	020104	48 - 240 lbf.in	5 - 25 N.m	10 lbf.in	1 N.m
ADS25F	020105	4 - 20 lbf.ft	5 - 25 N.m	0.5 lbf.ft	1 N.m
ADS40	020106	72 - 360 lbf.in	8 - 40 N.m	10 lbf.in	1 N.m
ADS40F	020107	6 - 30 lbf.ft	8 - 40 N.m	1 lbf.ft	1 N.m
BDS80A	020108	12 - 60 lbf.ft	16 - 80 N.m	1 lbf.ft	2 N.m
BDS80AS	020109	12 - 60 lbf.ft	16 - 80 N.m	1 lbf.ft	2 N.m
BDS80E	020110	12 - 60 lbf.ft	16 - 80 N.m	1 lbf.ft	2 N.m
BDS80ES	020111	12 - 60 lbf.ft	16 - 80 N.m	1 lbf.ft	2 N.m
BDS160	020112	24 - 120 lbf.ft	32 - 160 N.m	2 lbf.ft	2.5 N.m
BDS160S	020113	24 - 120 lbf.ft	32 - 160 N.m	2 lbf.ft	2.5 N.m
BDS200	020114	30 - 160 lbf.ft	40 - 200 N.m	5 lbf.ft	5 N.m
BDS200S	020115	30 - 160 lbf.ft	40 - 200 N.m	5 lbf.ft	5 N.m
CDS400S	020117	60 - 300 lbf.ft	80 - 400 N.m	10 lbf.ft	10 N.m
DDS800S	020119	120 - 600 lbf.ft	160 - 800 N.m	20 lbf.ft	20 N.m
EDS1400	020120	200 - 1000 lbf.ft	280 - 1400 N.m	25 lbf.ft	25 N.m
EDS2000	020121	300 - 1500 lbf.ft	400 - 2000 N.m	50 lbf.ft	50 N.m

	Sq. Drive in.	Light Signal	Head Ht.		Length		Weight	
			in.	mm	in.	mm	lbs.	kg.
ADS4	1/4	*	2.40	61	9.60	244	1.15	0.52
ADS8	1/4	*	2.40	61	9.60	244	1.15	0.52
ADS12D	1/4	*	2.40	61	9.60	244	1.15	0.52
ADS12A	3/8	*	2.70	69	9.60	244	1.15	0.52
ADS25	3/8	*	2.70	69	9.60	244	1.15	0.52
ADS25F	3/8	*	2.70	69	9.60	244	1.15	0.52
ADS40	3/8	*	2.70	69	9.60	244	1.15	0.52
ADS40F	3/8	*	2.70	69	9.60	244	1.15	0.52
BDS80A	3/8	-	3.06	78	17.12	435	2.98	1.35
BDS80AS	3/8	Yes	3.06	78	17.31	440	3.24	1.47
BDS80E	1/2	-	3.39	86	17.12	435	3.00	1.36
BDS80ES	1/2	Yes	3.39	86	17.31	440	3.28	1.49
BDS160	1/2	-	3.39	86	20.27	515	3.10	1.41
BDS160S	1/2	Yes	3.39	86	20.47	520	3.39	1.54
BDS200	1/2	-	3.39	86	20.27	515	3.10	1.41
BDS200S	1/2	Yes	3.39	86	20.47	520	3.39	1.54
CDS400S	3/4	Yes	4.38	111	27.95	705	6.94	3.15
DDS800S	3/4	Yes	4.88	123	39.37	1000	10.70	4.85
EDS1400	1	Yes	5.40	138	80.3	2040	36.72	16.69
EDS2000	1	Yes	5.40	138	80.3	2040	36.72	16.69

NOTE!

* SPECIAL ORDER
 All Light Signal Wrenches use standard size batteries.
 All ADS - EDS wrenches available in single scale models.
 ADS and BDS models are supplied with a protective plastic case.
 EDS models available with single or double-end, but not with a ratchet end.
 For Single-End Spindle, specify SE after the model name. Example: ADS4-SE

EXTENSION SPANNERS

Special extensions spanners are available upon request. When ordering, please provide the following information:

- A) Square drive size.
- B) Size of spanner end.
- C) End type - Box, Open, or Flared.
- D) Center distance between the square drive and the spanner end fitting.
- E) Maximum torque to be applied.

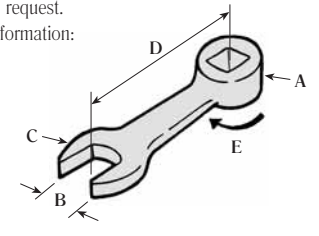

NOTE!
 Due to the low torque ranges and high accuracy, it is recommended that models ADS4 & ADS8 should not be used with Extension Spanners.

EXTENSION ADAPTERS

Adapters offer an alternative solution for overcoming space and access limitations and are available upon request.

1. Place the end fitting to the extension adapter.
2. Attach to the wrench's square drive.
3. Measure and note distance "E" from the center of the end fitting to the wrench square drive.

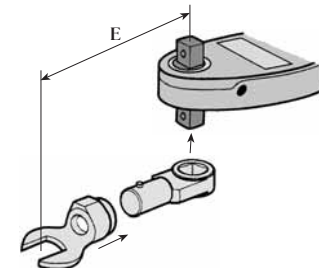

Square Drive	16mm Spigot Item #	9x12 End Fitting Item #	Dovetail End Fitting Item #
3/8"	20-A96102	20-A96112	20-A96122
1/2"	20-A96103	20-A96113	20-A96123

NOTE!
 Extension Adapters cannot be used with the ADS4, ADS8 and ADS12D.
 When using extension spanners or adapters, the torque applied to the fastener is greater than that shown on the torque wrench dial. To calculate the increase, please use the formula on website.

WSTT

Weld Stud Test Tool



KEY FEATURES

Designed and manufactured to meet or exceed the accuracy and repeatability requirements of ISO 6789:2003.

- Tools < 10 N.m (\pm 6% of setting): WSTT 10
- Tools > 10 N.m (\pm 4% of setting): WSTT 20

The Weld Stud Test Tool is designed for use during the production of sheet metal products to test the strength and integrity of welds used to attach threaded studs to the sheet metal.

"T" shaped handle for easy operation.

Bi-directional.

Tamper-proof internal adjustment. No external adjustment scale - must be preset using a torque analyzer.

Interchangeable end fittings are available.

Ideal tool for the automotive and appliance industry.

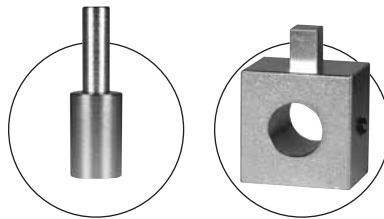

PIN SETTING ADAPTERS

The system comprises of two components:

1) WSTT Setting Adapter - Item #061461

Adapter with 1/4 male square drive and a pin-mounting hole, which accepts a variety of pin sizes.

2) Select pin size for the End Fitting on the WSTT:

Item #	Model
061461-44	Pin for WSTT End Fitting 4-40
061461-66	Pin for WSTT End Fitting 6-32
061461-88	Pin for WSTT End Fitting 8
061461-100	Pin for WSTT End Fitting 10
061461-250	Pin for WSTT End Fitting 1/4
061461-31	Pin for WSTT End Fitting 5/16
061461-37	Pin for WSTT End Fitting 3/8

061461-25	Pin for WSTT End Fitting 2.5mm
061461-3	Pin for WSTT End Fitting 3mm
061461-4	Pin for WSTT End Fitting 4mm
061461-5	Pin for WSTT End Fitting 5mm
061461-6	Pin for WSTT End Fitting 6mm
061461-8	Pin for WSTT End Fitting 8mm
061461-10	Pin for WSTT End Fitting 10mm
061461-12	Pin for WSTT End Fitting 12mm



NOTE!

The pin & blank setting adapters are used for setting the torque of the WSTT with a torque analyzer.

Model	Item #	Torque Ranges		
		lbf.in	N.m	kgf.cm
WSTT 10	020367	9 - 89	1 - 10	10 - 102
WSTT 20	020368	35 - 177	4 - 20	41 - 204

Model	Break	Length		Weight	
		in.	mm	oz.	gm.
WSTT 10	20°	8.5	215	4.2	120
WSTT 20	20°	12.5	320	7.8	220

METRIC END FITTINGS

Size	Item # for WSTT 10	Item # for WSTT 20
M2.5 x 25	020550	-
M3 x 50	020551	-
M4 x 50	020552	-
M5 x 50	020553	020556
M6 x 50	020554	020557
M8 x 50	020555	020558
M10 x 75	-	020559
M12 x 75	-	020560

AMERICAN END FITTINGS

Size	Item # for WSTT 10	Item # for WSTT 20
4-40 x 1.5"	020561	-
6-32 x 2"	020562	-
8-32 x 2"	020563	-
10-32 x 2.5"	020564	020567
10-24 x 2.5"	020565	020568
1/4-20 x 4"	020566	020569
5/16-18 x 4"	-	020570
3/8-16 x 4"	-	020571



BLANK SETTING ADAPTER

Item #020572

The Setting Adapter features a 3/8" square drive on one side. The other end features a blank end so you can weld the appropriate weld stud.

GET EASY TEST RESULTS

A simple way to test the shear torque of weld studs. Apply a straight pull of the WSTT wrench (no side load). When the wrench breaks-over and the weld stud is still attached then it passed. If the weld stud breaks off - then it failed.

Interchangeable Heads



Size mm	For MTBN2, MTBN10 Max. Torque Capacity: 10 N.m			Open End		Box End		Flare End		
	Item #	Max Torque Capacity N.m	Item #	Max Torque Capacity N.m	Item #	Max Torque Capacity N.m	Item #	Max Torque Capacity N.m		
3.2	022000		022250	-	-	-	-	-		
4	-		022255	-	-	-	-	-		
5	020429		020528	-	-	-	-	-		
5.5	022015		022265	-	-	-	-	-		
6	020430		022270	-	-	-	-	-		
7	022025		022275	040407	9	040476	25	040530	4	
8	020427		022280	022505	040410	13	040426	35	040528	7
9	022035		022285	022510	040411	19	040427	45	040533	9
10	020508		022290	022515	040412	25	040428	52	040444	12
11	022045		022295	022520	040413	32	040429	73	040445	16
12	020431		022300	022525	040414	41	040430	89	040446	25
13	022055		022305	022530	040415	51	040431	107	040447	28
14	020428		022310	022535	040416	63	040432	128	040448	31
15	020432		022315	022540	040417	77	040433	150	040449	38
16	022070		022320	022545	040105	92	040434	175	040450	46
17	022075		022325	022550	040106	107	040435	201	040451	53
18	022080		022330	-	040418	128	040436	230	040452	65
19	022085		022335	022555	040419	149	040437	261	040229	74
20	022090		022340	-	040420	172	040438	294	040453	86
21	022095		022345	022222	040421	196	040439	330	040454	100
22	022100		022350	022560	040422	225	040440	330	040455	112
23	022105		022355	020496	040423	255	040441	330	040456	123
24	022110		022360	022565	040424	287	040442	330	040457	143
25	022115		022365	-	040425	322	040443	330	-	-
26	-		-	-	040409	330	-	-	-	-
27	-		-	-	040110	330	040478	330	040555	150
30	-		-	-	040650	330	-	-	-	-
32	-		-	-	040107	330	-	-	-	-
36	-		-	-	040111	330	-	-	-	-
5/32"	020415		022400	-	-	-	-	-	-	-
3/16"	020411		020405	-	-	-	-	-	-	-
7/32"	020414		022410	-	-	-	-	-	-	-
1/4"	020401		020396	022600	040047	7	040056	25	049748	4
5/16"	020402		020424	020426	040048	13	040057	35	040750	7
3/8"	020403		022425	020420	040072	21	040058	42	040041	9
7/16"	020407		020422	020419	040049	32	040059	73	040042	15
1/2"	020408		020421	022620	040050	48	040060	115	040043	23
9/16"	020404		022440	022625	040051	67	040061	170	040044	32
5/8"	020409		020417	020463	040052	90	040062	226	040045	44
11/16"	020418		021116	-	040053	118	040063	260	040310	58
3/4"	020397		022455	022635	040054	150	040064	305	040071	74
13/16"	022225		022460	-	040304	187	040065	330	040301	93
7/8"	020423		022465	022640	040073	230	040066	330	040311	114
15/16"	020425		022470	-	040055	281	040307	330	040312	140
1"	020410		022475	022645	040305	330	040067	330	040313	166
1 1/16"	-		-	-	040306	330	040308	330	040314	166
1 1/8"	-		-	-	040327	330	069712	330	-	-
1 3/16"	-		-	-	040716	330	-	-	040651	166
1 1/4"	-		-	-	040315	330	049742	330	040309	166
1 5/16"	-		-	-	060375	330	-	-	-	-
1 1/2"	-		-	-	065433	330	-	-	-	-

METRIC HEADS

AMERICAN HEADS

Item #

Accessories

Torque Wrenches



SMA CONNECTOR TOOLS

The correct tightening of SMA Connectors used in RF cabling applications is essential to ensure optimum performance. This is particularly important in high frequency applications using stainless steel or beryllium-copper bodies.

A torque value of around 1 N.m is generally being specified by connector manufacturers for the tightening of precision connectors and around 0.5 N.m for brass bodied connectors.

TB Break-Over wrenches & Hand Torque Screwdrivers are tools available to accurately tighten SMA connectors and to ensure that over tightening cannot occur. The TB is commonly used with an open ended spanner (usually 8mm), while the pre-set Minor Screwdriver with a Crowsfoot Spanner Head enables vertical access in places where conventional torque tools cannot be used. Spanners are available to suit the A/F sizes of all the major connector manufacturers.

Other sizes and lengths available upon request.

CROWSFOOT SPANNER HEADS

(For Hand Torque Screwdrivers)

Model	Length			Length		
	in.	mm	Item #	in.	mm	Item #
1/4" Crowsfoot Spanner	3	76.2	061670	5	127	066100
5/16" Crowsfoot Spanner	3	76.2	061628	5	127	066101
3/8" Crowsfoot Spanner	3	76.2	061585	5	127	066103
7/16" Crowsfoot Spanner	3	76.2	061621	5	127	066104
1/2" Crowsfoot Spanner	3	76.2	061622	5	127	066105
5mm Crowsfoot Spanner	3	76.2	061624	5	127	066102
8mm Crowsfoot Spanner	3	76.2	061619	-	-	-
14mm Crowsfoot Spanner	3	76.2	061623	5	127	066106
17mm Crowsfoot Spanner	-	-	-	5	127	066107
18mm Crowsfoot Spanner	3	76.2	061625	5	127	066108
19mm Crowsfoot Spanner	3	76.2	061626	5	127	066109

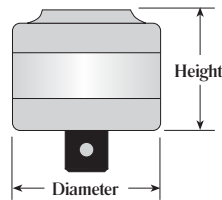

RATCHETING ADAPTERS

Enables controlled tightening in combination with DM Series wrenches.

Sturdy ratchet head made of chrome vanadium steel.

Operates in Clockwise direction.

Square Drive	Item #	Height		Diameter		Weight	
		in.	mm	in.	mm	oz.	gm.
1/4"	110116	7/8	21	15/16	24	1.8	50
3/8"	110117	1 1/8	28	1 3/8	35	5.3	150
1/2"	110118	1 3/8	35	1 13/16	46	12.4	350
3/4"	110119	2 1/16	53	2 9/16	65	35.4	1000
1"	110120	2 1/2	63	2 7/8	73	88.4	2500

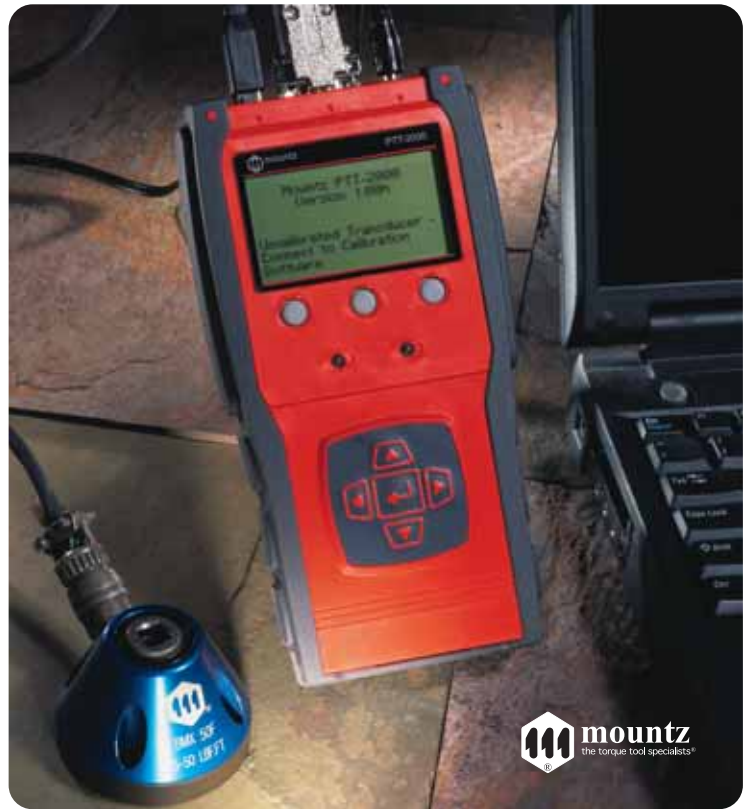

TORQUE ANALYZER & TEST MEASUREMENT CATALOG - MC14

Ask a Mountz customer service representative for a copy of our Torque Analyzer & Test Measurement Catalog (24 page). (Available in Print or PDF format)



TORQUE MULTIPLIER CATALOG - MC14

Ask a Mountz customer service representative for a copy of our Torque Multiplier Catalog (24 page). (Available in PDF format only)

When ordering special extended bits, we need the specific information below to provide a quote.

Special Bits

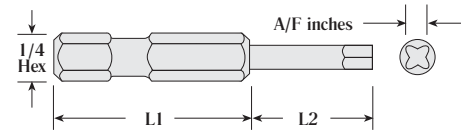
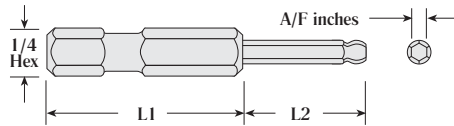
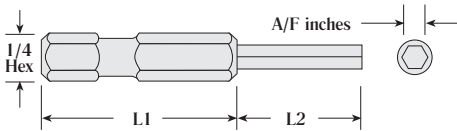
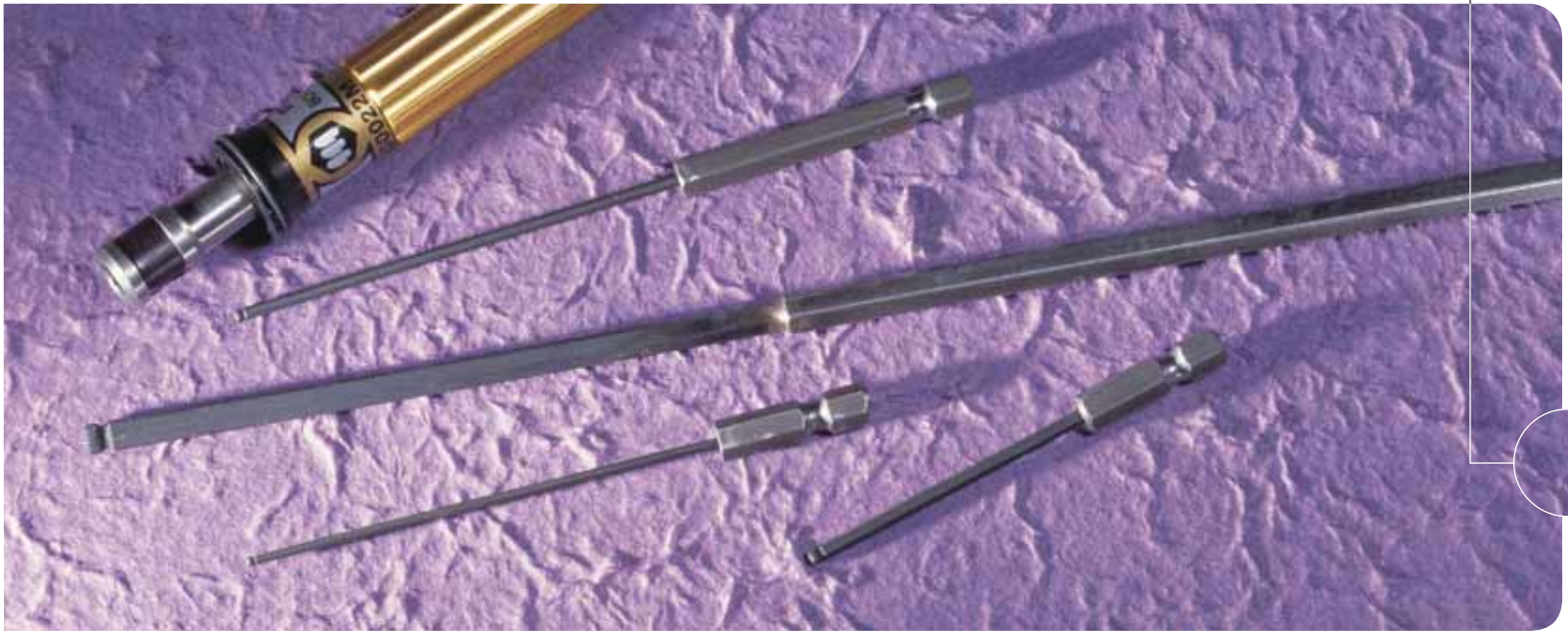

HEX BITS or BLADES

AMERICAN		METRIC	
A/F	L2 (max.)	A/F	L2 (max.)
.05"	3"	1.5mm	3 1/4"
1/16"	3 1/4"	2mm	4 3/4"
5/64"	3 1/2"	2.5mm	5 1/2"
3/32"	3 3/4"	3mm	7 1/4"
7/64"	7"	3.5mm	4 1/2"
1/8"	7 1/2"	4mm	8 1/4"
9/64"	8"	5mm	9 1/4"
5/32"	8 1/2"	6mm	10"
3/16"	9 1/4"	8mm	10 3/4"
1/4"	6"		
5/16"	7"		

BALL POINT BITS or BLADES

AMERICAN		METRIC	
A/F	L2 (max.)	A/F	L2 (max.)
.05"	3"	1.5mm	3 1/4"
1/16"	3 1/4"	2mm	4 3/4"
5/64"	3 1/2"	2.5mm	5 1/2"
3/32"	3 3/4"	3mm	7 1/4"
7/64"	7"	3.5mm	4 1/2"
1/8"	7 1/2"	4mm	8 1/4"
9/64"	8"	5mm	9 1/4"
5/32"	8 1/2"	6mm	10"
3/16"	9 1/4"	8mm	10 3/4"
1/4"	6"		
5/16"	7"		

SPLINE BITS or BLADES

A/F	L2 (max.)	Flutes
.048"	2.7"	4
.060"	2.7"	6
.069"	2.7"	6
.072"	2.7"	6
.076"	2.7"	6
.096"	2.7"	6
.0111"	2.7"	6
.145"	4.5"	6

ORDERING SYSTEM

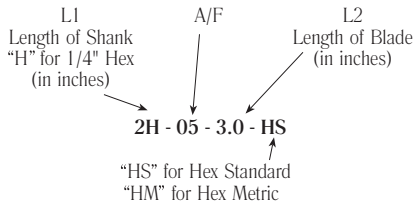

ORDERING SYSTEM

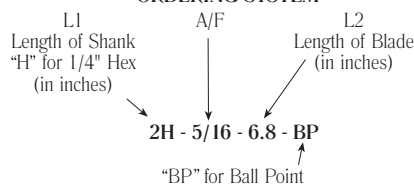

ORDERING SYSTEM

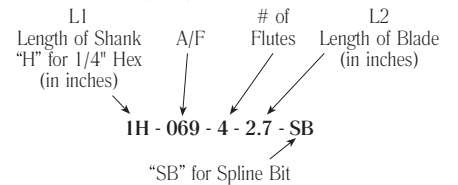

NOTE!

Bits in excess of 4" long are subject to "bowing".



TLS MINIMASTER HAND SCREWDRIVER

Torque Limiting Screwdriver
Internally Adjustable
See Section 01
Page 01.3 & 01.4

etorque.com

ISO 9001 and ISO 17025 Company

SPECIAL BITS

04.1

Power Bits

For use with ALL Drivers

POZIDRIVE®

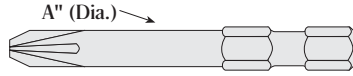

Drive Size	1 ¹⁵ / ₁₆ " OL		2 ³ / ₄ " OL		3" OL		3 ¹ / ₂ " OL		6" OL		A"
	Item #	PQ*	Item #	PQ*	Item #	PQ*	Item #	PQ*	Item #	PQ*	
O-PZD	122512	10	-	-	-	-	-	-	-	-	1/8
1-PZD	120162	10	120335	10	-	-	120599	10	120334	1	3/16
2-PZD	120163	10	120189	10	120337	10	120582	10	120359	1	1/4
3-PZD	120164	5	120579	5	120947	5	120207	5	120331	1	1/4

*OL = Overall Length *PQ = Package Quantity

TORXALIGN® WEDGE



Overall Length 1¹⁵/₁₆"

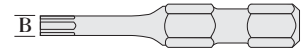

Drive Size	Item #	A"	B"	Package Quantity
T-6	120510	.187	.065	1
T-7	120511	.187	.077	1
T-8	120512	.187	.090	1
T-9	120513	.187	.097	1
T-10	120514	.187	.107	1
T-15	120350	.187	.128	1
T-20	120515	.187	.151	1
T-25	120516	.187	.173	1
T-27	120517	.25	.195	1
T-30	120518	.25	.216	1



BALLPOINT

(hex)



Overall Length 3" / 76mm

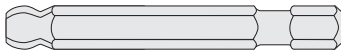

Hex Size	Item #	Cap Screw Size	Set Screw Size	Package Quantity
5/64"	120013	2 - 3	8	10
3/32"	120014	4 - 5	10	10
7/64"	120015	6	-	5
1/8"	120016	-	1/4	5
9/64"	120018	8	-	10
5/32"	120019	10	5/16	10
3/16"	120017	1/4	3/8	10
7/32"	120020	-	7/16	10
1/4"	120021	5/16	1/2	5
5/16"	120011	3/8	5/8	1
3/8"	120869	7/16, 1/2	3/4	1
1/2"	120001	5/8	7/8	1
2mm	120626	M2.5	M4	5
2.5mm	120627	M3	M5	5
3mm	120628	M4	M6	5
4mm	120629	M5	M8	5
5mm	120630	M6	M10	5
6mm	120631	M8	M12	5
8mm	120632	M10	M16	1
10mm	120633	M12	M18 / M20	1
12mm	120635	M14	M22 / M24	1

TORX®

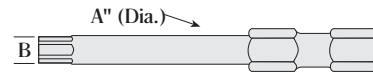

Drive Size	1 ¹⁵ / ₁₆ " OL		2 ³ / ₄ " OL		3 ¹ / ₂ " OL		6" OL		A"	B"
	Item #	PQ*	Item #	PQ*	Item #	PQ*	Item #	PQ*		
T-1	126059	1	-	-	-	-	-	-	.098	.033
T-2	126060	1	-	-	-	-	-	-	.098	.037
T-3	126053	1	-	-	-	-	-	-	.098	.044
T-4	126054	1	-	-	-	-	-	-	.098	.051
T-5	121463	1	122017	1	122032	1	122047	1	.125	.055
T-6	121469	1	122018	1	120508	5	120556	1	.125	.065
T-7	120002	1	120344	1	120341	1	120506	1	.125	.077
T-8	120288	1	120338	1	-	-	120502	1	.125	.090
T-9	-	-	121026	1	120507	1	120724	1	.125	.097
T-10	120457	1	120190	1	120870	5	120558	1	.156	.107
T-15	120440	5	120358	1	120352	1	120216	1	.156	.128
T-20	120458	5	120330	1	120349	1	120222	1	.187	.151
T-25	120459	5	120332	1	120764	1	120720	1	.187	.173
T-27	120460	5	120948	1	120755	1	120721	1	.25	.195
T-30	120461	1	120751	1	-	-	120722	1	.25	.216
T-40	120462	1	-	-	-	-	120723	1	.296	.260

*OL = Overall Length *PQ = Package Quantity

TORX-SET®

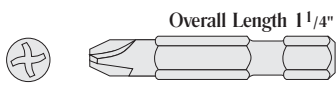

Overall Length 1 1/4"

Screw Size	Item #	Package Quantity
TS1-2	120553	1
TS1-4	120555	1
TS1-8	121477	5

SLOTTED



Screw Size	1 15/16" OL		2 3/4" OL		3" OL		3 1/2" OL		4" OL		6" OL		A"	B"
	Item#	PQ*	Item #	PQ*	Item #	PQ*	Item #	PQ*	Item #	PQ*	Item #	PQ*		
1F-2R	120175	10	120730	5	120224	5	120734	5	120475	1	120217	1	.122	.026
2F-3R	120176	10	120223	5	120192	5	120483	5	120485	5	120420	1	.134	.03
3F-4R	120177	10	120405	5	123321	1	120284	5	123319	1	120433	1	.154	.034
4F-5R	120178	10	-	-	120194	5	120203	5	120306	5	120290	1	.187	.036
5F-6R	120179	10	120409	5	120195	5	-	-	120304	5	120545	1	.215	.038
6F-7R	120180	10	120184	5	120196	5	120285	5	120580	5	120435	1	.25	.04
8F-10R	120181	10	120731	10	120197	5	120474	5	120581	5	120436	1	.275	.042
10F-12R	120182	10	120732	5	120198	5	120208	5	120946	5	120532	1	.312	.046
12F-14R	120183	5	120733	5	120199	5	120594	5	120608	1	120736	1	.360	.05

*OL = Overall Length *PQ = Package Quantity



PHILLIPS

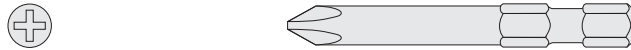

Point Size	1 15/16" OL		2 3/4" OL		3" OL		3 1/2" OL		4" OL		6" OL	
	Item#	PQ*	Item #	PQ*	Item #	PQ*	Item #	PQ*	Item #	PQ*	Item #	PQ*
0	120005	5	120831	5	-	-	120006	5	-	-	124916	1
1	120159	10	120186	10	120200	10	120204	10	120210	10	120214	5
2	120160	10	120187	10	120201	10	120205	10	120211	10	120215	5
3	120161	10	120188	10	120202	10	120206	10	120212	10	120437	5

*OL = Overall Length *PQ = Package Quantity

Point Size	Screw Size	Machine Screws				A"
		Flat Oval Binding	Round Fillster	Truss-Brazier Button		
0	0-1	0-1	0-1	0-1	1/8	
1	2-3-4	2-3-4	2-3-4	2-3-4-5	3/16	
2	5-6-7-8-10	5-6-7-8-10	5-6-7-8-10	6-8-10	1/4	
3	12-14	12-14	12-14-15-16	12-14	1/4	

SOCKET HEAD (allen type)

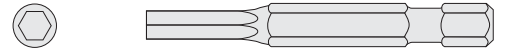

Hex Size	Item #	Cap Screw Size	Set Screw Size	Package Quantity	
1/16"	120165	1	5 - 6	5	American
5/64"	120166	2 - 3	8	1	
3/32"	120167	4 - 5	10	5	
7/64"	120218	6	-	5	
1/8"	120169	-	1/4	5	
9/64"	120170	8	-	5	
5/32"	120171	10	5/16	5	
3/16"	120172	1/4	3/8	5	
1/4"	120174	5/16	1/2	5	
5/16"	129808	5/8	5/8	1	
1.5mm	120777	M1.6 / M2	M3	1	Metric
2mm	120778	M2.3 / M2.5 / M2.6	M4	1	
2.5mm	120796	M3	M5	1	
3mm	120797	M4	M6	1	
4mm	120848	M5	M8	1	
5mm	120841	M6	M10	1	
6mm	120348	M8	M12	1	
8mm	120849	M10	M16	1	



SS-SERIES ELECTRIC SCREWDRIVER

Low voltage driver with "Soft-Stop" clutch. See Page 02.7

Insert Bits

For use with ALL Drivers

PHILLIPS

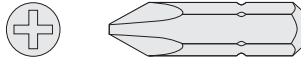

Point Size	Item #	Overall Length	Package Quantity
0	120107	1"	10
1	120108	1"	10
2	120110	1"	10
3	120112	1"	10

PHILLIPS - REDUCED SHANK

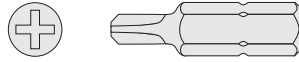

Overall Length	Item #	Point Size	Package Quantity
1"	120109	1	10
1"	120111	2	10
2"	120291	1	10
2"	120292	2	10
3"	120309	2	10



ERGO MICRO TORQUE HAND SCREWDRIVER

Torque Limiting Screwdriver
Externally Adjustable
See Section 02
Page 02.6



TORX®

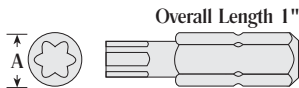

Drive Size	Item #	A"	Package Quantity
T-1	126051	.033	1
T-2	126052	.037	1
T-3	126057	.044	1
T-4*	126054	.051	1
T-5	124405	.055	5
T-6*	120601	.065	5
T-7	120303	.077	5
T-8	120128	.090	5
T-9	120129	.097	5
T-10	120130	.107	5
T-15	120131	.128	5
T-20	120132	.151	5
T-25	120133	.173	5
T-27	120134	.195	5
T-30	120135	.216	10
T-40	120381	.260	10

* OAL is 1¹⁵/₁₆"

TAMPER RESISTANT TORX®

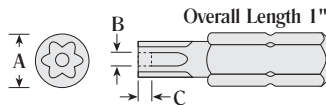

Drive Size	Item #	A"	B"	C"	Package Quantity
T-7	120550	.077	-	-	1
T-8	120533	.090	.045	.030	1
T-9	120534	.097	.050	.032	1
T-10	120537	.107	.055	.037	1
T-15	120523	.128	.062	.047	1
T-20	120524	.151	.078	.062	1
T-25	120522	.173	.085	.077	1
T-27	120521	.195	.095	.087	1
T-30	120551	.216	.112	.107	1
T-40	120552	.260	.134	.124	1

TORXALIGN® WEDGE

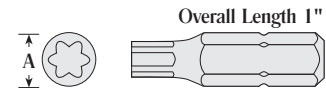

Drive Size	Item #	A"	Package Quantity
T-6	120612	.065	5
T-7	120549	.077	5
T-8	120519	.090	5
T-9	120944	.097	5
T-10	120247	.107	5
T-15	120505	.128	5
T-20	120548	.151	5
T-25	120535	.173	5
T-27	120945	.195	5
T-30	120547	.216	5



**TLS MICRO MINIMASTER
HAND SCREWDRIVER**

Torque Limiting Screwdriver
Internally Adjustable
See Section 02
Page 02.3 & 02.4

POZIDRIVE®

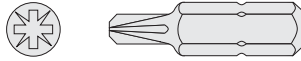

Overall Length	Item #	Point Size	Package Quantity
1"	120113	1-PZD	10
1"	120114	2-PZD	10
1"	120115	3-PZD	10

SLOTTED

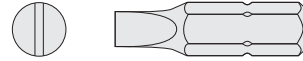

Overall Length	Item #	Blade		Screw Size	Package Quantity
		Thickness	Width		
1 1/2"	120136	.034"	.187"	4F-5R	10
1 1/2"	120137	.040"	.250"	6F-8R	10
1 1/2"	120138	.042"	.281"	8F-10R	10
1 1/2"	120139	.046"	.281"	10F-12R	10
1 1/2"	120140	.050"	.281"	12F-14R	10
1 1/2"	120141	.055"	.359"	14F-16R	5



**HEX
(Allen Type)**

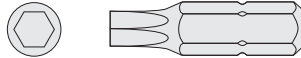

	Hex Size	Item #	Overall Length	Cap Screw Size	Set Screw Size	Package Quantity
American	.050"	120003	1"	0	3 - 4	5
	1/16"	120116	1"	1	5 - 6	10
	5/64"	120117	1"	2 - 3	8	10
	3/32"	120118	1"	4 - 5	10	10
	7/64"	120119	1"	6	-	10
	1/8"	120120	1"	-	1/4	10
	9/64"	120155	1"	8	-	5
	5/32"	120122	1"	10	5/16	10
	3/16"	120123	1"	1/4	3/8	10
	7/32"	120124	1"	-	7/16	10
Metric	1/4"	120125	1"	5/16	1/2	10
	5/16"	120126	1"	3/8	5/8	10
	3/8"	120127	1"	3/16, 1/2	3/4	5
	1.5mm	120859	25.4mm	M1.6/2	M3	1
	2mm	120399	25.4mm	M2.3/2.5/2.6	M4	10
	2.5mm	120363	25.4mm	M3	M5	10
	3mm	120360	25.4mm	M4	M6	10
	4mm	120361	25.4mm	M5	M8	10
	5mm	120362	25.4mm	M6	M10	10
	6mm	120364	25.4mm	M8	M12	10
8mm	120365	25.4mm	M10	M16	5	

**BALLPOINT
(Hex)**

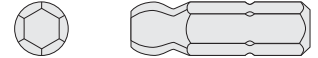

	Hex Size	Item #	Overall Length	Cap Screw Size	Set Screw Size	Package Quantity
American	5/64"	120710	1"	2 - 3	8	5
	3/32"	120711	1"	4 - 5	10	5
	7/64"	120712	1"	6	-	5
	1/8"	120713	1"	-	1/4	5
	9/64"	120714	1"	8	-	5
	5/32"	120715	1"	10	5/16	5
	3/16"	120716	1"	1/4	3/8	5
	7/32"	120717	1"	-	7/16	5
	1/4"	120718	1"	5/16	1/2	5
	5/16"	120962	1.5"	3/8	5/8	1
Metric	3/8"	120963	1.5"	7/16, 1/2	3/4	1
	1/2"	120964	1.5"	5/8	7/8	1
	2mm	120620	25.4mm	M2.5	M4	5
	2.5mm	120621	25.4mm	M3	M5	5
	3mm	120622	25.4mm	M4	M6	5
	4mm	120623	25.4mm	M5	M8	5
	5mm	120624	25.4mm	M6	M10	5
	6mm	120625	25.4mm	M8	M12	5
	8mm	120965	38.1mm	M10	M16	1
	10mm	120966	38.1mm	M12	M18, M20	1
12mm	120967	38.1mm	M14	M22, M24	1	

HIOS Bits

For use with electric screwdrivers with a drive size of 4mm HIOS or 5mm HIOS.



4MM PHILLIPS

Point Size	Package Quantity	Overall Length				
		40mm 1.58"	60mm 2.37"	80mm 3.15"	100mm 3.94"	120mm 4.72"
00	5	144408	144407	144406	144405	-
0	5	144416	144417	-	144419	-
1	5	144422	144423	144424	144425	144461
2	5	144428	144429	144430	144431	144475

Item #

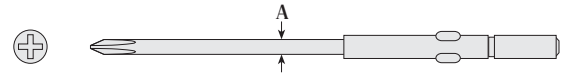

4MM PHILLIPS REDUCED SHANK

Point Size	Package Quantity	Overall Length				A mm
		40mm 1.58"	60mm 2.37"	80mm 3.15"	100mm 3.94"	
00	5	144411	144412	144413	144414*	1.5
0	5	144409*	144477	144478	-	1.5
0	1	-	144467	-	-	1.8
0	5	144460	144455	144448	144404	2.0
0	5	144403	144466	144456	144457	2.5
1	5	144410	144421	144602	144426	3.0

Item #

* These bits are not sold in a package quantity of 5. Sold as individual bits.

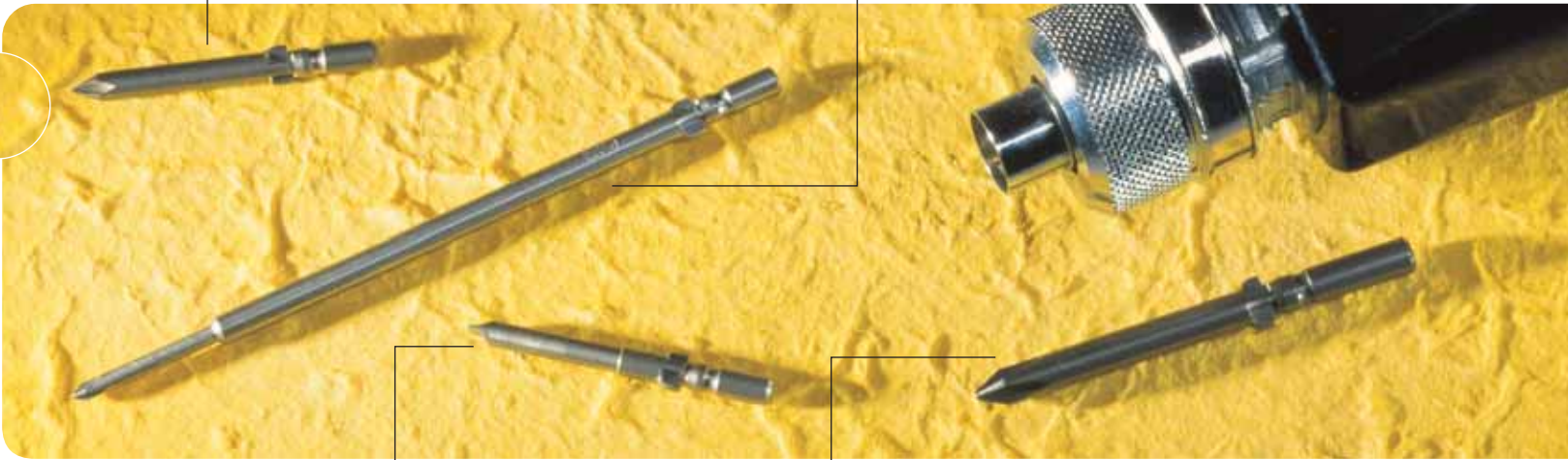

4MM SLOTTED

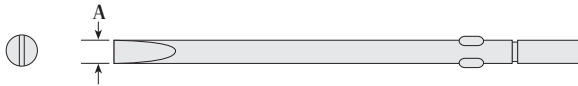

40mm 1.58"	Overall Length		Package Quantity	Width "A"		Blade Thickness	
	60mm 2.37"	80mm 3.15"		in.	mm	in.	mm
-	144434	144463	5	.043	1.1	.011	.28
-	144435	144464	5	.051	1.3	.011	.28
144458	144436	144500	5	.059	1.5	.012	.30
144459	144437	144611	5	.067	1.7	.012	.30
-	144438	144621	5	.071	1.8	.016	.40
144441	144442	144606	5	.079	2.0	.016	.40
-	144443	144607	5	.091	2.3	.016	.40
144445	144446	144608	5	.098	2.5	.016	.40
-	144447	144609	5	.110	2.8	.016	.40
144449	144450	144601	5	.118	3.0	.016	.40
144451	-	-	5	.138	3.5	.016	.40
144453	144454	144462	5	.157	4.0	.024	.60

Item #



**ELECTRIC
SCREWDRIVER**
CL6500
Low Voltage DC
See Page 02.10

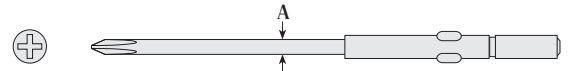

5MM PHILLIPS REDUCED SHANK

Point Size	Package Quantity	Overall Length			A mm
		60mm 2.37"	80mm 3.15"	100mm 3.94"	
0	5	144670	144622	144432	2.5
1	5	144444	144605	144415	3.0

Item #

5MM PHILLIPS

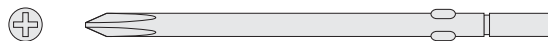

Point Size	Package Quantity	Overall Length							
		60mm 2.37"	80mm 3.15"	100mm 3.94"	150mm 5.9"	180mm 7.07"	200mm 7.87"	250mm 9.84"	300mm 11.8"
1	5	144433	144600	144476	144603	144483	144484	144485	144604
2	5	144439	144465	144470	144482	144488	144440	144486	144481

Item #

Miniature Bits



PHILLIPS

Bit Point	Item #	Screw Size	Package Quantity
000	120084	000	5
00	120075	00	10
0	120061	0, 1	5
1	120062	2, 3, 4	5



SLOTTED

Blade Width	Item #	Blade Thickness	Package Quantity
.055"	120063	.010"	10
.070"	120064	.012"	10
.080"	120065	.015"	10
.100"	120066	.015"	10

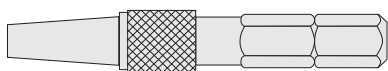
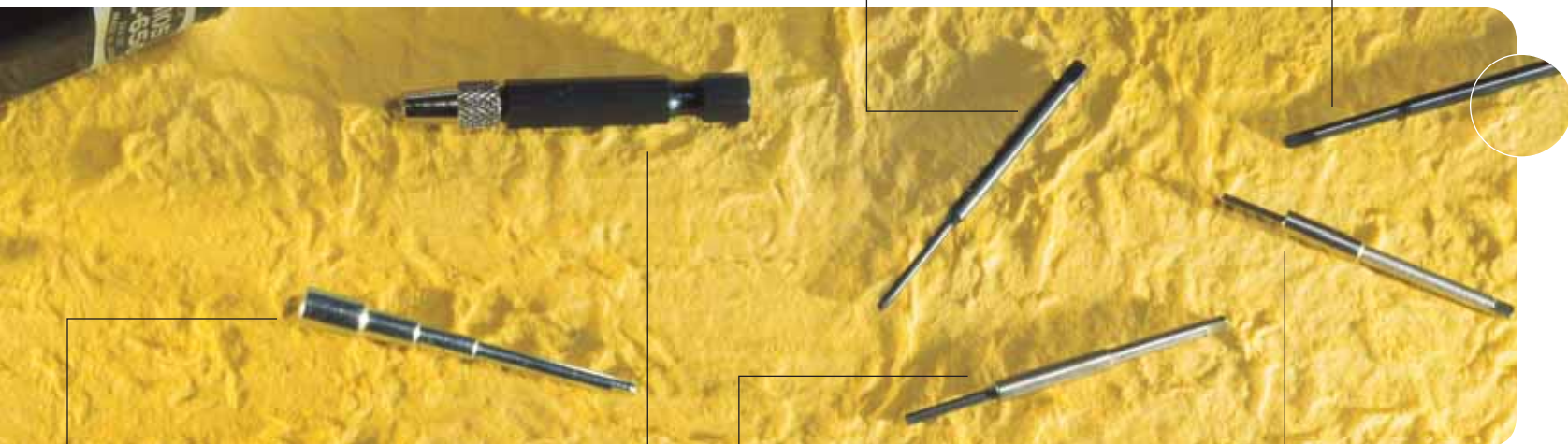

1/4 HEX INSERT PIN CHUCK

Size	Item #	Chuck Dia.	Length in.
1/4 Hex	020248	3/32	1 1/8

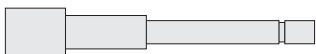

NUT DRIVERS

Hex Opening	Item #	Socket O.D.	Package Quantity
5/64"	120054	.140	5
3/32"	120055	.170	5
7/64"	120056	.170	5
1/8"	120057	.200	5
5/32"	120058	.230	5

Miniature Hex Bit when compared to the size of a toothpick.



HEX BITS (Allen Type)



Bit Dia.	Item #	Set Screw#	A*	B*	C*	D*	Package Quantity
.028"	120079	0	-	-	-	-	10
.035"	120080	1, 2	-	-	0	0	10
.050"	120081	3, 4	0	0, 1	1, 2	1, 2	10
1/16"	120082	5, 6	1	2	3, 4	3, 4	10
5/64"	120083	8	2, 3	3, 4	5, 6	5, 6	10

A* = Socket Head 60 Series
 B* = Socket Head 36 Series
 C* = Flat Head
 D* = Button Head

MULTIPLE SPLINE BITS



Bit Dia.	Item #	# of Flutes	Set Screw#	A*	C*	D*	Package Quantity
.033"	120071	4	0, 1	-	-	-	1
.048"	120072	4	2, 3	-	-	-	5
.048"	120070	6	2, 3	4	0	0	10
.060"	120073	6	4	0	6	1, 2	5
.069"	120074	4	5	-	-	-	10

A* = Socket Head 60 Series
 C* = Flat Head
 D* = Button Head



Miniature Slotted Bit placed into the 1/4" Hex Insert Pin Chuck.

Bit Holders

For use with ALL Drivers



SCREW CAP RETAINER

(non-magnetic)

Length	Item #	Drive	Diameter	
			Body	Nose
2 7/16"	120258	1/4 Hex	3/8"	7/16"
4"	120301	1/4 Hex	3/8"	7/16"
6"	120302	1/4 Hex	3/8"	7/16"

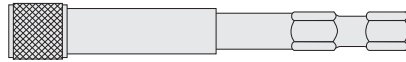

SCREW CAP RETAINER

(magnetic)

Length	Item #	Drive	Diameter	
			Body	Nose
2 3/8"	120411	1/4 Hex	3/8"	7/16"
2 7/8"	120241	1/4 Hex	3/8"	7/16"
4"	120243	1/4 Hex	3/8"	7/16"
5"	120244	1/4 Hex	3/8"	7/16"
6"	120245	1/4 Hex	3/8"	7/16"
11"	120248	1/4 Hex	3/8"	7/16"

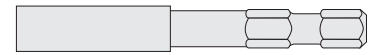

C-RING RETAINER

(magnetic)

Length	Item #	Drive	Body Dia.
2 1/8"	120999	1/4 Hex	3/8"
2 7/8"	120242	1/4 Hex	3/8"
4"	120470	1/4 Hex	3/8"
6"	120471	1/4 Hex	3/8"
11"	120472	1/4 Hex	3/8"



NARO DRIVER & BIT SET

Item # 125003



FLEXIBLE DRIVER AND BIT SET

Item # 125000



AUTOLOCK BIT HOLDER 60MM (NON-MAGNETIC)

Item # 125001

AUTOLOCK BIT HOLDER 60MM (MAGNETIC)

Item # 125006

Nutsetters

For use with ALL Drivers

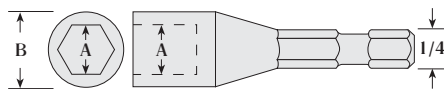

MAGNETIC

Hex Size "A"	Item #	Overall Length	Socket Body Diameter "B"
3/16"	128806	2"	5/16"
1/4"	120430	1 5/8"	7/16"
1/4"	120743	2 9/16"	7/16"
1/4"	121037	4"	7/16"
1/4"	120970	6"	7/16"
5/16"	120431	1 5/8"	1/2"
5/16"	120323	2 9/16"	1/2"
5/16"	128810	3"	1/2"
3/8"	126165	1 7/8"	9/16"
3/8"	120256	2 9/16"	9/16"
3/8"	128812	3"	9/16"
7/16"	120746	2 9/16"	5/8"
5mm	128807	2 9/16"	1/4"
6mm	120705	1 5/8"	1/4"
7mm	120708	1 5/8"	7/16"
8mm	120706	1 5/8"	1/2"
10mm	120707	1 7/8"	9/16"

NON-MAGNETIC

Hex Size "A"	Item #	Overall Length	Socket Body Diameter "B"
3/16"	120007	2"	5/16"
3/16"	120008	3"	5/16"
1/4"	120262	1 5/8"	7/16"
1/4"	120740	2 9/16"	7/16"
1/4"	120808	3"	7/16"
5/16"	120263	1 5/8"	1/2"
5/16"	120741	2 9/16"	1/2"
5/16"	128102	2"	1/2"
5/16"	128103	3"	1/2"
5/16"	120887	4"	1/2"
5/16"	128106	6"	1/2"
11/32"	128112	2"	9/16"
11/32"	128113	3"	9/16"
3/8"	120264	1 7/8"	9/16"
3/8"	128122	2"	9/16"
3/8"	120742	2 9/16"	9/16"
7/16"	120322	2"	21/32"
7/16"	128143	3"	21/32"
7/16"	120592	6"	21/32"
1/2"	120052	2"	3/4"
1/2"	128163	3"	3/4"
4mm	120880	2 9/16"	11/32"
5mm	120840	2 9/16"	11/32"

Adapters & Sockets

For use with ALL Drivers

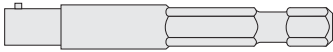

SQUARE DRIVE ADAPTER

Sq. Drive	Item #	Drive	Overall Length
1/4"	120142	1/4 Hex	1"
1/4"	120225	1/4 Hex	1 3/8"
1/4"	120143	1/4 Hex	2"
1/4"	120144	1/4 Hex	3"
1/4"	120145	1/4 Hex	4"
1/4"	120146	1/4 Hex	6"
1/4"	120147	1/4 Hex	8"
3/8"	120148	1/4 Hex	2"
3/8"	120149	1/4 Hex	3"

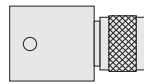

FEMALE TO FEMALE ADAPTER

Sq. Drive	Item #	Drive	Overall Length
1/4"	120260	1/4 F/Hex	1 1/8"
3/8"	120261	1/4 F/Hex	1 15/16"
1/2"	120530	5/16 F/Hex	1 1/2"
1/2"	120634	1/4 F/Hex	1 3/4"

1/4" FEMALE SQUARE DRIVE TO 1/4" F/HEX Item # 205640

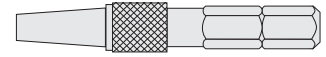
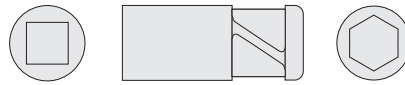

1/4" HEX INSERT PIN CHUCK

Size	Item #	Chuck Dia.	Length
1/4 Hex	020248	3/32"	1 1/8"

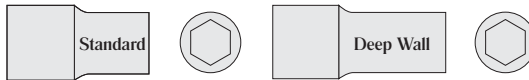

STANDARD 1/4" SQ. DR. SOCKETS

6pt. American		8pt. American		6pt. Metric	
A/F US	Item #	A/F US	Item #	A/F Metric	Item #
1/8"	230042	-	-	4 mm	230577
5/32"	240037	-	-	4.5 mm	230575
3/16"	230049	-	-	5 mm	230578
7/32"	230050	-	-	5.5 mm	230576
1/4"	230043	1/4"	230560	6 mm	230579
9/32"	230044	-	-	7 mm	230580
5/16"	230045	5/16"	230561	8 mm	230581
11/32"	230046	-	-	9 mm	230582
3/8"	230047	3/8"	230562	10 mm	230583
7/16"	230048	-	-	11 mm	230584
1/2"	230056	-	-	12 mm	230585

6 PT. DEEP WALL 1/4" SQ. DR. SOCKETS

A/F US	Item #	A/F Metric	Item #
1/4"	230563	4 mm	230587
9/32"	230564	5 mm	230904
5/16"	230565	6 mm	230905
11/32"	230566	7 mm	230089
3/8"	230567	8 mm	230083
7/16"	230568	9 mm	230906
1/2"	230569	10 mm	230090
		11 mm	230907
		12 mm	230908
		13 mm	230091

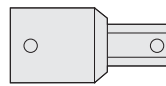

ADAPTER

Size, Square Male x Female	Item #
1/4" x 3/8"	230060
3/8" x 1/4"	230061
3/8" x 1/2"	230065
1/2" x 3/8"	230062
1/2" x 3/4"	230063
3/4" x 1/2"	230068
3/4" x 1"	230066
1" x 3/4"	230067

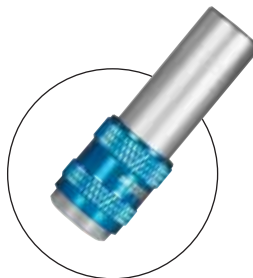

1/4" M/HEX BIT HOLDER 45MM

Item #125002

American

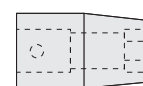

Metric

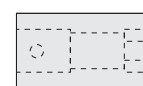

Magnetic Power Socket

POWER SOCKETS 1/4" SQ. DR.

Hex Size	Standard			Deep Wall		
	Mag. Item #	Non-Mag. Item #	Overall Length	Mag. Item #	Non-Mag. Item #	Overall Length
3/16"	120249	-	7/8"	-	-	2"
7/32"	-	120342	7/8"	-	120784	2"
1/4"	120250	120270	7/8"	120295	-	2"
9/32"	120251	120271	7/8"	120296	120379	2"
5/16"	120252	120272	7/8"	-	-	-
11/32"	120253	120259	1"	120310*	120380	2"
3/8"	120254	120274	1"	120298	120597	2"
7/16"	120255	120275	1"	120299	120598	2"
1/2"	-	120779	1"	-	121218	1.75"
9/16"	-	120763	1"	-	120785	1.75"
3.5mm	120953	120900	22.2mm	-	-	-
4mm	120333	121179	22.2mm	-	-	-
4.5mm	120954	120955	22.2mm	-	-	-
5mm	120864	121180	22.2mm	-	-	-
5.5mm	120888	120956	22.2mm	-	-	-
6mm	124959	121181	22.2mm	-	-	-
7mm	120497	120499	22.2mm	-	121187	44.4mm
8mm	120931	120957	22.2mm	-	121082	44.4mm
9mm	120958	120959	22.2mm	-	120961	44.4mm
10mm	120498	120960	22.2mm	-	121084	44.4mm

* 1 3/4" OAL

ADAPTERS & SOCKETS

What is Torque?

Torque is a “turning” or “twisting” force and differs from tension, which is created by a straight pull. However, we use torque to create a tension.

HOW?

(Diagram A) As the nut and bolt are tightened, the two plates are clamped together. The thread angle in the bolt converts the force applied into tension (or stretch) in the bolt shank. The amount of the tension created in the bolt is critical.

WHY?

A bolt tensioned properly works at its optimum efficiency and will resist coming undone. However, if the tension is too low, the nut could vibrate or work loose. If the tension is too high (overstretched), the bolt could break. Every bolt has a correct optimum torque/tension figure for each fastening application. It is important to have these figures available so that the end product will be safe, efficient and economical.

HOW DO WE MEASURE TORQUE?

(Diagram B) Torque is the result of multiplying the value of Force applied by the Distance from the point of application.

Comparing the two examples, please note that the same Torque result can be achieved with a lower Force if the Distance from the nut/bolt is increased.

Another factor that affects applied torque when using torque wrenches is if it is “length dependent,” which means that the actual torque applied to the fastener varies if the hand position on the wrench is varied (even if the wrench is preset). This occurs if the pivot point of the wrench mechanism is not coincidental with the point of application of torque.

THE IMPORTANCE OF TORQUE CONTROL?

The reliability of machine parts subjected to fluctuating loads and stress depends on the fatigue strength of the materials. A threaded fastener, however, relies upon an elastic interaction between the mating components. Its objective is to clamp parts together with a tension greater than any external force trying to separate them. The bolt then remains under almost constant stress and is immune to fatigue. If the initial bolt tension is too low, the fluctuating load in the shank is much greater and it will quickly fail. Reliability, therefore, depends on correct initial tension and is ensured by specifying and controlling the tightening torque.

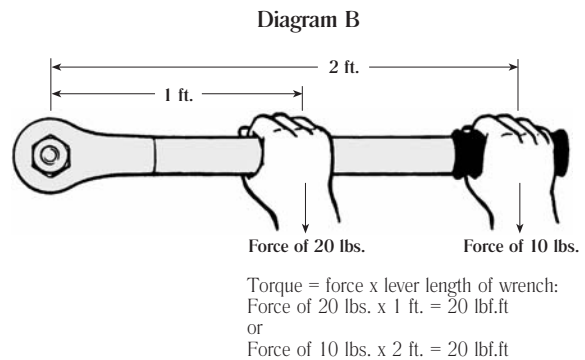
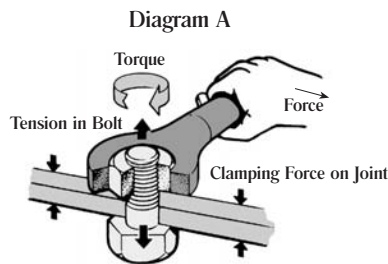

INTERNATIONAL TORQUE MEASURING SYSTEMS

International Systems - S.I.

mN.m - milli Newton meter
 cN.m - centi Newton meter
 N.m - Newton meter

American

ozf.in - ounce force inch (referred as inch-ounces)
 lbf.in - pound force inch (referred as inch-pounds)
 lbf.ft - pound force foot (referred as foot-pounds)

Metric

gf.cm - gram force centimeter
 kgf.cm - kilogram force centimeter
 kgf.m - kilogram force meter



DM TORQUE WRENCHES

Lightweight design crafted with high-strength aluminum alloy. Full-metal construction. Single square drive for controlled clockwise tightening. Double square drive for controlled bi-directional tightening.

SEE PAGE O3.12

Calculations

TORQUE CONVERSION CHART

Units to Convert	American			S.I.			Metric		
	ozf.in	lbf.in	lbf.ft	mN.m	cN.m	N.m	gf.cm	kgf.cm	kgf.m
mN.m	0.142	0.009	0.0007	1	0.1	0.001	10.2	0.01	0.0001
cN.m	1.416	0.088	0.007	10	1	0.01	102	0.102	0.001
N.m	141.6	8.851	0.738	1000	100	1	10.197	10.2	0.102
ozf.in	1	0.0625	0.005	7.062	0.706	0.007	72	0.072	0.0007
lbf.in	16	1	0.083	113	11.3	0.113	1152.1	1.152	0.0115
lbf.ft	192	12	1	1356	135.6	1.356	13.826	13.83	0.138
gf.cm	0.014	0.0009	0.00007	0.098	0.01	0.0001	1	0.001	0.00001
kgf.cm	13.89	0.868	0.072	98.07	9.807	0.098	1000	1	0.01
kgf.m	1389	86.8	7.233	9807	980.7	9.807	100.000	100	1

Example 1:

Convert 10 lbf.ft to cN.m

$$\frac{\text{lbf.ft}}{10} \times 135.6 = 135.6 \text{ cN.m}$$

Example 2:

Convert 14 kgf.m to lbf.ft

$$\frac{\text{kgf.m}}{14} \times 7.233 = 101.26 \text{ lbf.ft}$$

CALCULATIONS FOR TORQUE WRENCH ADAPTERS & SPANNERS

Note: when using extension adapters and spanners, the torque applied to the nut is greater than that shown on the torque wrench dial. To calculate the increase, use the formula below:

$$TT = \frac{DR(L + E)}{L}$$

TT = True Torque
DR = Dial Reading
E = Extension Length
L = Effective Wrench Length

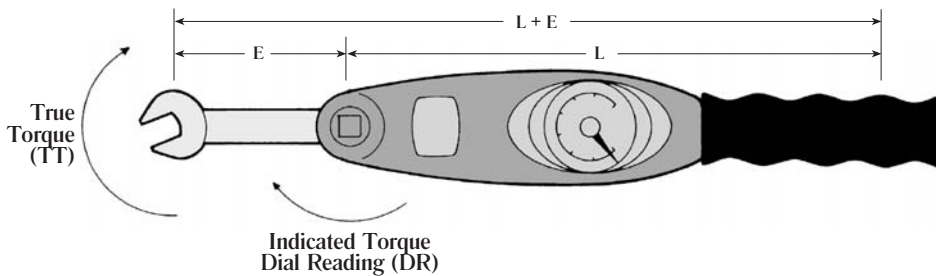

To ensure that the correct torque is applied when using extension spanners, keep the extension "in-line" with the axis of the wrench (as shown in diagram). Should you wish to permanently use an extension spanner on the Dial Type Wrenches, we can lock the ratchet mechanism and re-calibrate the dial to show a true torque reading for that particular extension. The following table gives the value of dimensions "L" for all Dial Type Wrenches. It is important to have "L" dimension for any wrench where an extension is required.

Dimensions "L"	All *ADS Models		BDS80, A/AS/E/ES		Other BDS Models		CDS		DDS		EDS	
	in.	mm	in.	mm	in.	mm	in.	mm	in.	mm	in.	mm
	7.5	190	14.5	368	17.5	445	25	635	33.5	850	68	1727

* Due to the low torque ranges and high accuracy it is recommended that Models ADS4 and ADS8 should not be used with extension spanners and models ADS4, ADS8 and ADS12D should not be used with extension adapters.



ANALYZERS, TRANSDUCERS & CALIBRATION EQUIPMENT

SEE OUR TORQUE ANALYZER & TEST MEASUREMENT CATALOG

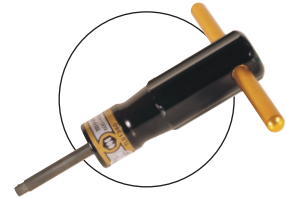

HAND TORQUE SCREWDRIVERS

SEE SECTION 01



POWER ASSEMBLY TOOLS

SEE SECTION 02

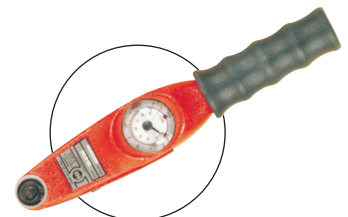

TORQUE WRENCHES

SEE SECTION 03



TORQUE MULTIPLIERS

SEE OUR TORQUE MULTIPLIER CATALOG



TORQUE ANALYZER & TEST MEASUREMENT CATALOG - MC14

Ask a Mountz customer service representative for a copy of our Torque Analyzer & Test Measurement Catalog (24 page). (Available in Print or PDF format)

**Torque Analyzers and Transducers
Test Measurement Equipment
Multiplexer & Bar Code Reader
Accessories**



TORQUE MULTIPLIER CATALOG - MC14

Ask a Mountz customer service representative for a copy of our Torque Multiplier Catalog (24 page). (Available in PDF format only)

**Hand Torque Multipliers
Pneumatic Torque Multipliers
Electric Torque Multipliers
Accessories**



CORPORATE HEADQUARTERS

1080 North 11th Street
San Jose CA 95112
t 408.292.2214
t 800.456.1828
f 408.292.2733
e-mail sales@etorque.com
www.etorque.com

DISTRIBUTION & SERVICE CENTER

19051 Underwood Road
Foley AL 36535
t 251.943.4125
f 251.943.4979

US & CANADA SALES OFFICES

Anaheim, Boston, Charlotte, Chicago, Cleveland,
Dallas, El Paso, Los Angeles, Minneapolis, Nashville,
Phoenix, Seattle, San Jose, Toronto

MOUNTZ MEXICO SA de CV

MAIN OFFICE & SERVICE CENTER

Av. Cristobal Colon #15343
Col. Paseos de Chihuahua
Chihuahua, Chih. Mexico CP 31125
t 614.481.0023
f 614.481.0053

MEXICO SALES OFFICES

Tijuana, Cd. Juarez, Chihuahua, Reynosa, Monterrey,
Mexico DF, Guadalajara